

# СВЕТОДИОД ARL-3535-TWA-UV280

## ОСОБЕННОСТИ

- Антибактериальное излучение, невидимый спектр 270–285нм.

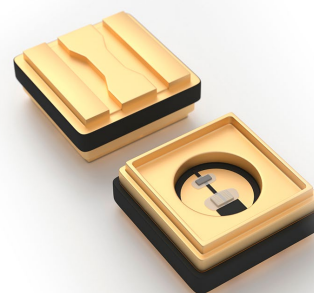

## ПРИМЕНЕНИЕ

- Дезинфекция и стерилизация воздуха, воды и поверхностей.
- Медицинское лечение и лечение кожных заболеваний.
- Эффективен против бактерий и вирусов (270–285 нм).

## ГАБАРИТНЫЕ РАЗМЕРЫ

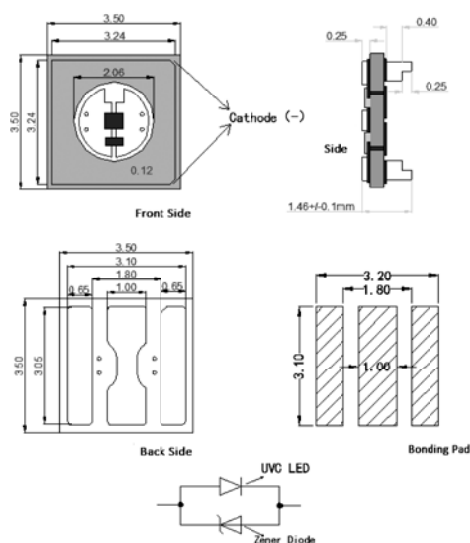

1. All dimensions in mm tolerance is ±0.1mm unless otherwise noted.
2. In addition to the UV LED chip, there is an additional zener diode welded in the device to provide ESD protection against electrostatic breakdown of the UV LED chip.

## ПАРАМЕТРЫ

### ABSOLUTE MAXIMUM RATINGS (AT TA=25 °C)

Parameter	Symbol	Rating	Unit
DC Forward Current	$I_F$	<b>60</b>	<b>mA</b>
Peak Pulse Current	$I_{FP}$	<b>150</b>	<b>mA</b>
Power Dissipation	$P_D$	<b>0.5</b>	<b>W</b>
Reverse Voltage	$V_R$	<b>10</b>	<b>V</b>
Reverse Current	$I_R$	<b>10</b>	<b>µA</b>
Operating Temperature Range	$T_{OPR}$	<b>-30 ~ +65</b>	<b>°C</b>
Storage Temperature Range	$T_{STG}$	<b>-40 ~ +75</b>	<b>°C</b>

#### Notes:

1. 1/10 Duty cycle, 0.1ms pulse width.
2. Care is to be taken that power dissipation does not exceed the absolute maximum rating of the product.
3. When the LEDs are in operation the maximum current should be decided after measuring the package temperature, junction temperature should not exceed the maximum rate. LED

### ELECTRICAL/OPTICAL CHARACTERISTICS-UVC (AT TA=25 °C)

Parameter	Symbol	Cond	Min	Avg.	Max	Units
Forward Voltage	$V_F$	$I_F=40mA$	<b>5.00</b>	—	<b>8.00</b>	<b>V</b>
Thermal Resistance Junction to Board	$R_{\theta J-B}$	$I_F=40mA$	—	<b>8</b>	—	<b>°C/W</b>
Radiant Flux	$\Phi_e$	$I_F=40mA$	<b>3</b>		<b>5</b>	<b>mW</b>
Peak Wavelength	$\lambda_p$	$I_F=40mA$	<b>270</b>		<b>280</b>	<b>nm</b>
Temperature Coefficient of Forward Voltage	$\Delta V_F/\Delta T$	$I_F=40mA$	—	<b>-2</b>	—	<b>mV/°C</b>
Reverse Current	$I_R$	$V_R=5V$	—	—	<b>10</b>	<b>µA</b>
Viewing Angle <sup>(1)</sup>	$2\theta_{1/2}$	$I_F=40mA$	—	<b>100</b>	—	<b>Deg</b>

#### Notes:

1. The above forward voltage measurement allowance tolerance is ±0.1V.
2. The tests shown above allow a tolerance of ±10%.
3. The wavelength measurement error shown above is plus or minus 0.1nm.
4.  $2\theta_{1/2}$  is the angle from optical centerline where the luminous intensity is 1/2 the optical centerline value.

# TYPICAL OPTICAL/ELECTRICAL CHARACTERISTICS CURVES

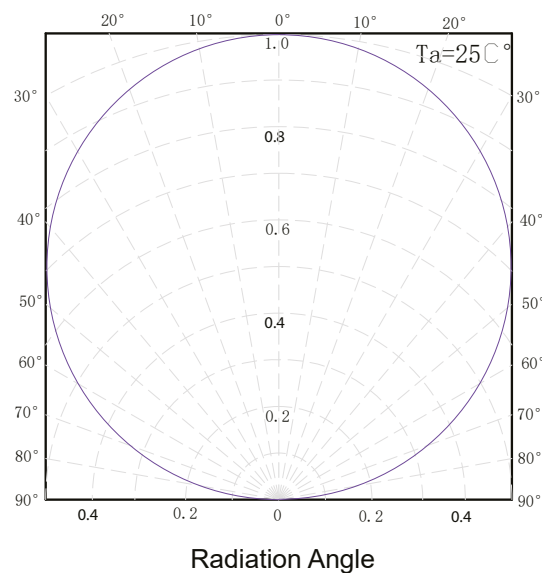
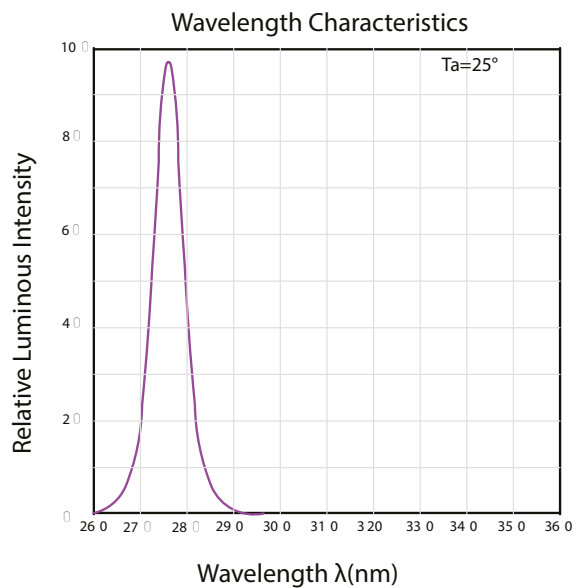
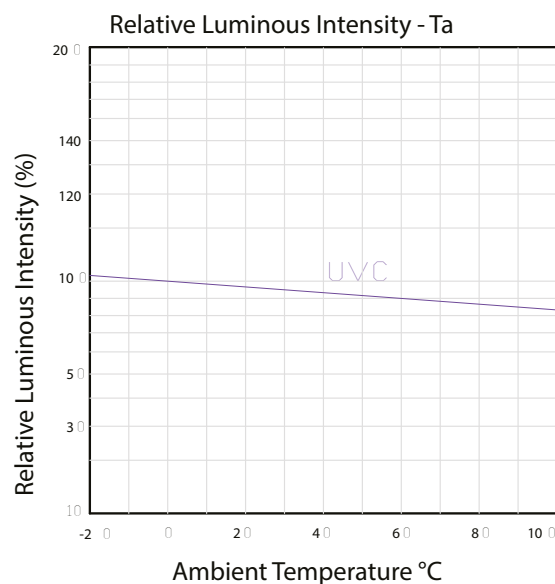
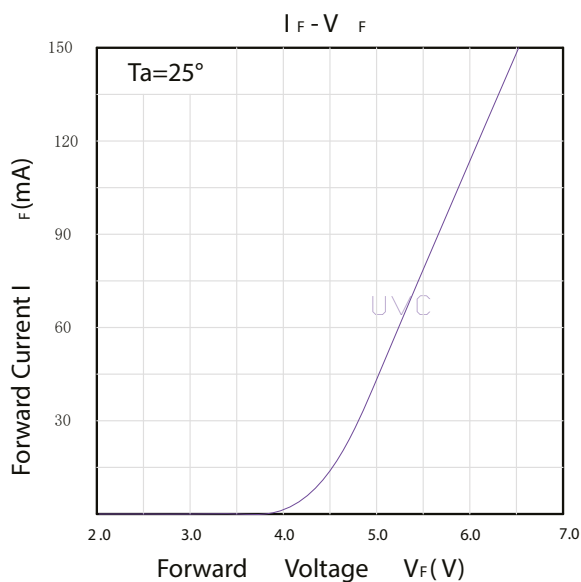
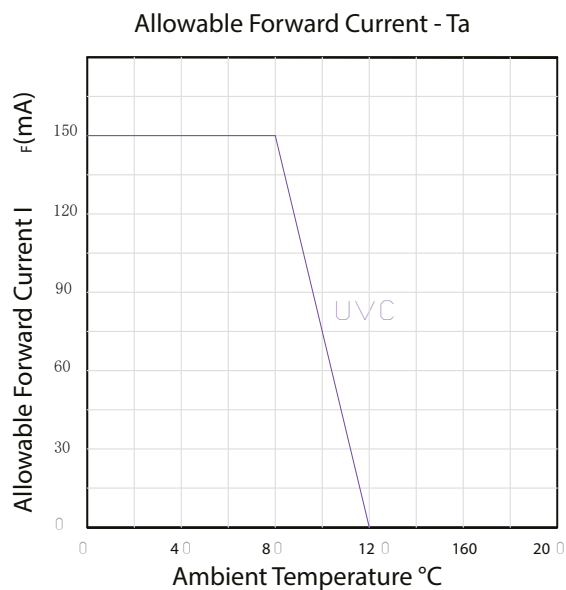
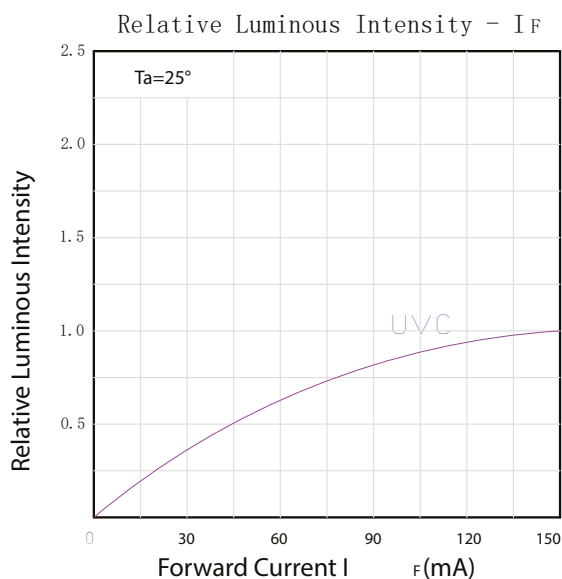

## RELIABILITY TEST STANDARDS

Test Item	REF. Standard	Test Condition	Duration	Sample Count	Accept
Temperature Cycle	JESD22-A104-A	100°±5 30min-25° 30min,5min,30min,5min	100 cycles	<b>22</b>	<b>0/22</b>
Thermal Shock	JESD22-A106	-40°-100° 30min, 30min	100 cycles	<b>22</b>	<b>0/22</b>
High Temperature Storage	JEITA ED-4701 200 201	TA=100°C±5°	1000 hrs	<b>22</b>	<b>0/22</b>
Low Temperature Storage	JEITA ED-4701 200 202	TA=-40°C±5°	1000 hrs	<b>22</b>	<b>0/22</b>
Humidity Heat Storage	JIS C 7021 (1977)B-11	Ta=60°C RH=85%	1000 hrs	<b>22</b>	<b>0/22</b>
Life Test	JESD22-A108-A	Ta=25°C If=40mA	1000 hrs	<b>22</b>	<b>0/22</b>
High Humidity Heat Life Test	JESD22-A101	Ta=60°C RH=85% IF=40mA	1000 hrs	<b>22</b>	<b>0/22</b>

## CRITERIA FOR JUDGING DAMAGE

Test Item	Symbol	Test Condition	Criteria for Judgement	
			Min	Max
Forward Voltage	VF	IF=40mA	—	U.S.L*]1.1
Reverse Current	IR	VR=10V	—	10uA
Luminous Flux	Lm	IF=40mA	L.S.L*]0.7	—
Lamp Bead Lighting Test	/	IF=40mA	—	

U.S.L.: Upper standard level

L.S.L.: Lower standard level

The above technical data is only the typical value of the product, not as any application conditions and application mode guarantee.

# SMT REFLOW SOLDERING INSTRUCTIONS SMT

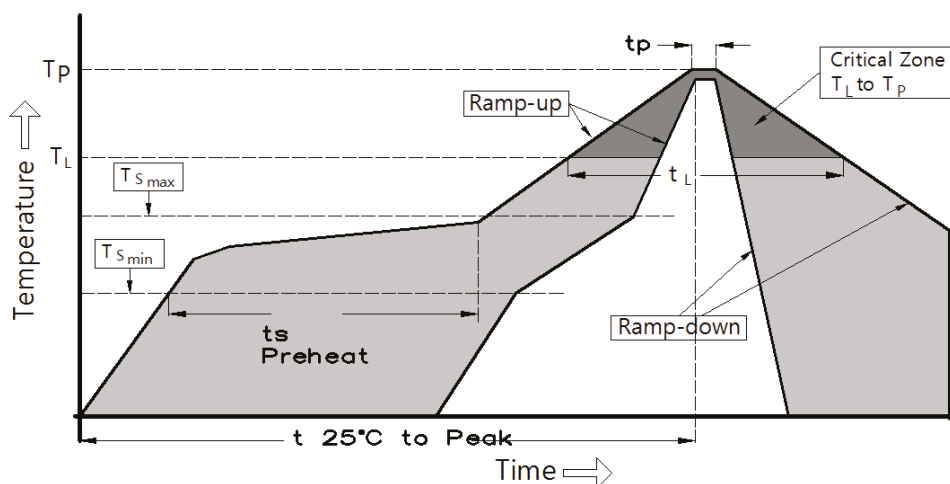

Average Temperature Rise Speed (T <sub>S max</sub> - T <sub>p</sub> )	3 °C/s; max 3 °C/s
Preheat: max (T <sub>S min</sub> )	100 °C
Preheat: max (T <sub>S max</sub> )	130 °C
Preheat: Time (T <sub>S min</sub> - T <sub>S max</sub> )	60-120/s
Time/(T <sub>L</sub> )	165 °C
Peak/(T <sub>L</sub> )	(max 60 s)
Peak / (T <sub>p</sub> )	180 °C
(T <sub>p</sub> )	(max 10 s)
(T <sub>p</sub> ) 5°	(max 30 s)
Temperature Fall Speed	(max 606 °C/s)
(Time of Temperature Rise from 25° to Peak Tem)	(max 8 minutes)

Notes for reflow [if reflow products are needed]:

1. Reflow soldering should not be done more than two times. In the case of more than 24 hours passed soldering after first, LEDs will be damaged.
2. When welding, do not press hard on the surface of the lens when the material is heated.
3. Scrape the heat-conducting solder paste on the aluminum baseplate, stir the solder paste clockwise for 10–5 minutes before scraping the solder paste, and place the aluminum baseplate.
4. Scrape solder paste steel mesh needs to be made into a cross, so as to allow air circulation, avoid solder paste lifting caused by LED poor heat dissipation on the solder paste scraping tool. Scrape the solder paste evenly and thickly.
5. Note that the lamp should be installed flat and the two pins of the LED light source should be installed on the welding pad position of the aluminum substrate.
6. Scrape the aluminum baseplate of solder paste in 2 hours to install all the light source, light source installed in the aluminum baseplate, the operator should selfcheck whether the light source is installed (can't have reverse, light source bottom suspension) to tilt 45 degrees angle to check each light source.
7. After reflow welding, check whether the light source is in the position of the welding pad, and do not have eccentric phenomenon, or the line will be broken in the second light distribution lens, resulting in open circuit.
8. Rapid cooling is not allowed after reflow soldering.
9. Do not weld on deformed PCB.

Soldering iron

1. When hand soldering, keep the temperature of iron below less 300° less than 3 seconds.
2. The hand solder should be done only one time.

Repairing

Repair should not be done after the LEDs have been soldered. When repairing is unavoidable, a double-head soldering iron should be used (as below figure). It should be confirmed in advance whether the characteristics of LEDs will or will not be damaged by repairing.

Cautions

1. LED product is lens package, the surface is relatively brittle, pressing the lens surface will affect the LED reliability, so there should be preventive measures to avoid pressing the device, when using the nozzle, the pressure on the lens surface should be appropriate.
2. Components should not be mounted on warped (non-coplanar) portion of PCB. After soldering, do not warp the circuit board.
3. Do not apply mechanical force or excess vibration during the cooling process to normal temperature after soldering. Do not rapidly cool device after soldering.

# PACKING STANDARD

NORMAL PACKING QUANTITY: 1000PCS/REEL

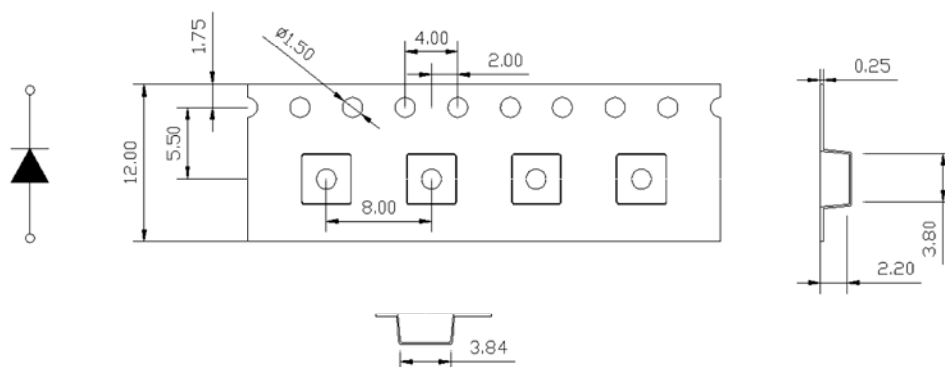

## REEL SPECIFICATIONS

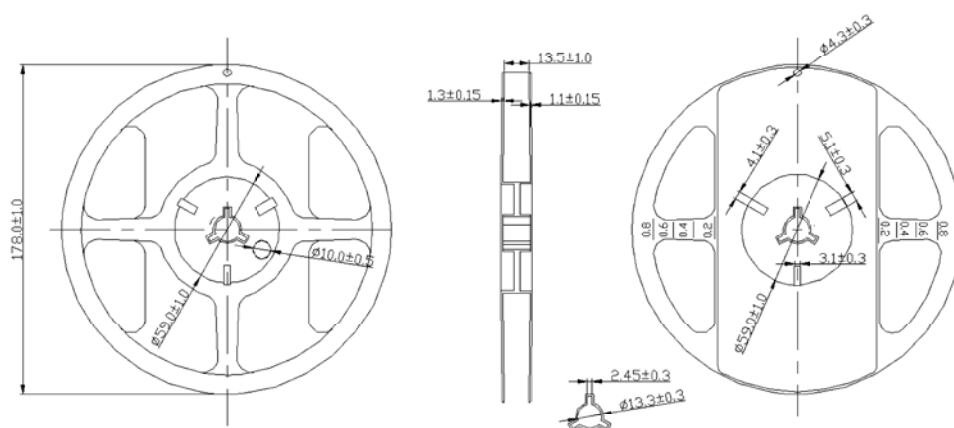

## MOISTURE RESISTANT PACKAGING

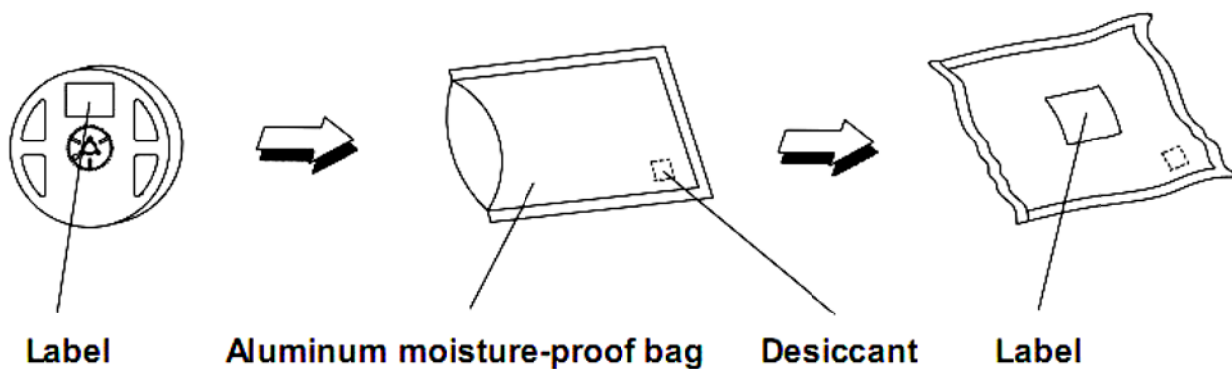

## PRODUCT SPECIFICATION

### Storage/use

1. In order to avoid moisture absorption, it is suggested to store the products in a drying cabinet with desiccant. The storage temperature is 5°-30°, and the humidity is ≤60% HR.
2. After storage for six months, it is recommended to reuse the spectral separation to prevent changes in photoelectric parameters.
3. It is recommended to dry products that have been sealed and stored for more than six months before use. The drying condition is 65°±5° for 10 hours.
4. The product shall be used within 24h after opening, otherwise it shall be baked at 65 °. for 4-6h before reflow welding.
5. Do not press the lens surface with any sharp object (such as tweezers). Do not leave fingerprints on the surface of the lens. The positive normal pressure of the lens body should be less than 2 newtons, and the times of press should be less than 3 times. The lateral pressure of the lens body is less than 1.5 newtons and the number of press is less than 3 times. Pick up materials correctly (as shown below).

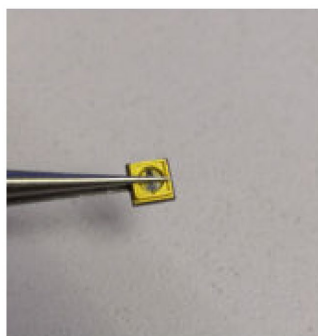

**NG**

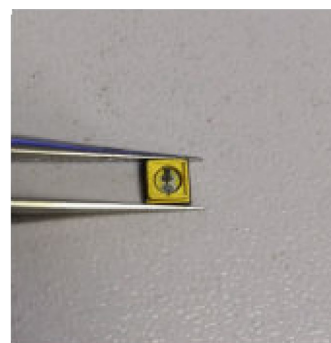

**OK**

Products should not be in contact with water, oil or organic solutions.

The operating current value of the product should consider LED junction temperature.  
Repackage unused products in moisture-proof bags and store in a dry place.

**Anti-static requirements: when using products, must wear anti-static ring or anti-static gloves, all equipment, devices, machines must be effectively grounded. This product belongs to electrostatic sensitive device, pay attention to anti-static protection!**

When LED working, push the temperature of PCB board should not exceed 60°.

Anti-vulcanization, chlorination, bromination and other treatments in the closed, high temperature environment, the lamp may contain sulfur/chlorine/bromine and other substances, these sulfur, chlorine and bromine elements will volatilize into gas and corrosion LED light source. Because the LED seal silica gel has porous structure, and the light source silver plating reaction occurred. After curing reaction of LED light source, the functional area of the product will darken, the luminous flux will gradually decline until it becomes slightly bright, and the color temperature will drift obviously, and the LED light source will eventually fail. It is recommended to conduct sulfur emission test of lamps first to ensure that LED light source works in sulfur-free/chlorine/bromine and other material environment.

Important safety tips.

This product will emit deep ultraviolet ray when properly operated and electrified. Direct exposure may cause harm to human skin and eyes. It is recommended to wear protective clothing, gloves and goggles during operation/use. Direct exposure to UV without protective measures or direct exposure to UV is strictly prohibited.



When the customer applies LED, it shall refer to the parameters of this specification and the requirements of operating environment. If the LED is used beyond the parameters or standard conditions without verification, our company will not make any quality guarantee.