

User Manual

Switch Actuator with Secure_V1.1

KNX-7043-82-DRO-DIN

KNX-7123-82-DRO-DIN

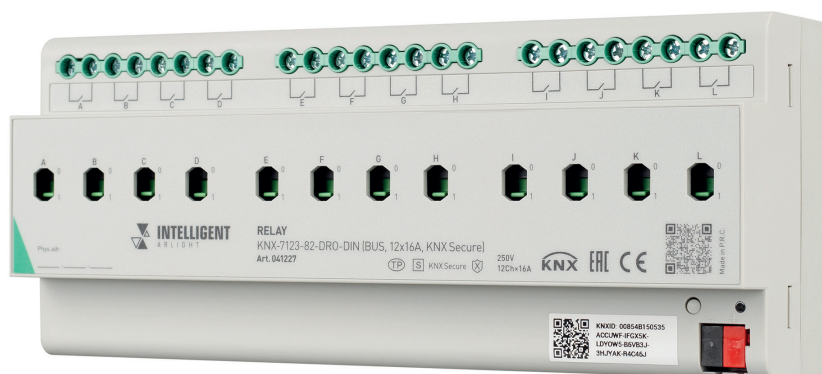

KNX/EIB Home and Building Control System

Attentions

1. Please keep devices away from strong magnetic field, high temperature, wet environment;



2. Please do not fall the device to the ground or make them get hard impact;



3. Please do not use wet cloth or volatile reagent to wipe the device;



4. Please do not disassemble the devices.

Contents

Chapter 1. Summary -----	1
Chapter 2. Technical Data -----	3
Chapter 3. Dimension and Connection Diagram -----	6
3.1. Dimension -----	6
3.2. Connection Diagram -----	7
3.2.1. KNX-7043-82-DRO-DIN -----	7
3.2.2. KNX-7123-82-DRO-DIN -----	8
Chapter 4. Parameters Setting Description in the ETS -----	10
4.1. KNX Secure -----	10
4.2. Parameter window "General" -----	14
4.3. Overview of output -----	17
4.4. Parameter window "Channel X"-Switch actuator -----	18
4.4.1. Parameter window "X: Time" -----	22
4.4.2. Parameter window "X: Preset" -----	28
4.4.3. Parameter window "X: Logic" -----	30
4.4.4. Parameter window "X: Scene" -----	33
4.4.5. Parameter window "X: Threshold" -----	35
4.4.6. Parameter window "X: Safety" -----	37
4.4.7. Parameter window "X: Forced" -----	38
4.5. Parameter window "Channel X"-Heating actuator -----	40
4.5.1. Parameter window "X: Monitoring" -----	44
4.5.2. Parameter window "X: Forced" -----	46
4.5.3. Parameter window "X: Regular" -----	47
4.5.4. Parameter window "X: Safety" -----	48
Chapter 5. Description of communication object -----	49
5.1. Communication object "General" -----	49
5.2. Communication object "Switch actuator" -----	50
5.2.1. General communication object "Switch actuator" -----	50
5.2.2. Time function object of "Switch actuator" -----	51
5.2.3. Preset function object of "Switch actuator" -----	52
5.2.4. Logic function object of "Switch actuator" -----	52
5.2.5. Scene function object of "Switch actuator" -----	53
5.2.6. Threshold function object of "Switch actuator" -----	53
5.2.7. Forced function object "Switch actuator" -----	54
5.3. Communication object "Heating actuator" -----	55
5.3.1. General communication object "Heating actuator" -----	55
5.3.2. Monitoring function object of "Heating actuator" -----	56
5.3.3. Forced function object "Heating actuator" -----	56
5.3.4. Regular switch function object "Heating actuator" -----	57
Chapter 6. Priority level description -----	58

Chapter 1. Summary

Switch Actuator with Secure is mainly applied in building control system, connected to the BUS via KNX terminals and installed together with other devices on the bus to become a system. These switch actuators can be used to control the switch loads, such as:

- ✧ Lighting
- ✧ Heating control
- ✧ Signal devices

It is able to switch from 4 to 12 independent electrical AC loads or three-phase loads by the switch actuators with maximum output of 16A per output and manual switch, as well as visible switching status.

Switch Actuator with Secure is modular installation devices in proM design, which are easy to install in the distribution boards on 35mm mounting rails according to EN60715. The devices connect to KNX system via bus connection terminal, and no additional power supply voltage is required. It is able to use the Engineering Tool Software ETS (ETS5 or later) with knxprod file to allocate the physical address and set the parameters.

This manual provides you the detailed technical information about the Switch Actuator with Secure, not only the installation and programming details, but also the usage explanation in actual application. There are some following programming functions for each output:

- **Manual operation available**
- **Time function: on/off delay**
- **Staircase function with the warning and adjustable staircase lighting time**
- **Scene, preset control: 8bit/1bit**
- **Logic operation: AND, OR, XOR, gate function**
- **Status response**
- **Forced operation and safety function**
- **Threshold function setup**
- **Control of electric thermal valve function**
- **Selection of preferred status after bus voltage failure and recovery**

- **Current and Power measurement**
- **Report total current and total power of device**
- **Monitoring channel current and total current**
- **Switching counter**
- **Operation hours counter**
- **Inversion of the outputs**
- **KNX Data Secure**

Chapter 2. Technical Data

Power supply	Bus voltage	21~30 V DC, via the KNX bus
	Bus current	<6.5mA/24V , <5.5mA/30V
	Bus consumption	<165mW
	Charging current	<20mA
Output	U _n rated voltage	250V AC(50/60Hz)
	I _n rated current	16A
	Inrush current	480A/2ms
Output life expectancy	Mechanical endurance	>10 ⁶
	Electrical endurance (Resistive load)	>10 ⁵
Connections	KNX	Bus connection terminal (0.8mmΦ)
	Load output connection terminal	Screw terminal
	Cross section	0.2—6.0mm ²
Operation and display	Programming LED and button	For assignment of the physical address
	Green LED flashing	Indicate the application layer running normally
	Indication of the contact position	Close means the output is on Open means the output is off
Protection	IP20	to EN 60529
Safety class	II	to EN 61140
Temperature	Operation	-5 °C ~+ 45 °C
	Storage	-25 °C~+ 55 °C
	Transport	-25 °C ~+ 70 °C
Ambient	Humidity	<93%, except dewing

	KNX-7123-82-DRO-DIN	216 × 90 × 64mm
Weight	KNX-7043-82-DRO-DIN	0.35kg
	KNX-7123-82-DRO-DIN	0.85kg

Product	Load type	Rated power	Life cycles
KNX-7043-82-DRO-DIN,	Incandescent lamp	4000W	>30000
	Halogen lamp	4000W	>5000
KNX-7123-82-DRO-DIN	Standard/Electronic ballast	4000W	>30000
	Fluorescent lamp (uncompensated)	4000W	>5000
	Fluorescent lamp (parallelcompensated)	2800W	>5000
	Motor	2200W	>30000
	LED (Inrush current470A/ 210us)	800W	>30000

Note: The above load is only for single lamps. In the case of several lamps in parallel, the load will be reduced, although the power is unchanged, but the instantaneous impact of current will increase, and easy to make the relay contacts melted. In normal use, the maximum output current is preferably less than 16A for resistive load, and inductive load and capacitive load will be lower.

Application program	Max. number of communication objects	Max. number of group addresses	Max. number of associations	Secure group addresses
Switch Actuator with Secure, KNX-7043-82-DRO-DIN	59	500	500	130
Switch Actuator with Secure, KNX-7123-82-DRO-DIN	171	500	500	390

Chapter 3. Dimension and Connection Diagram

3.1. Dimension

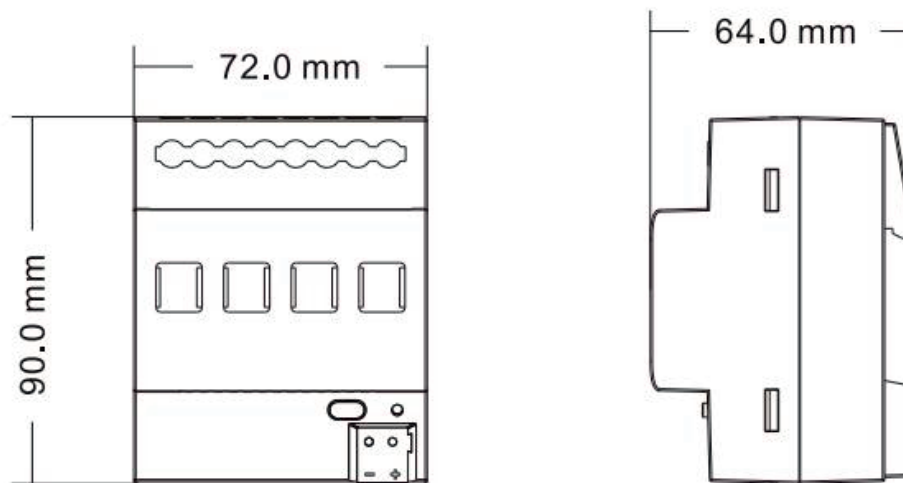

KNX-7043-82-DRO-DIN

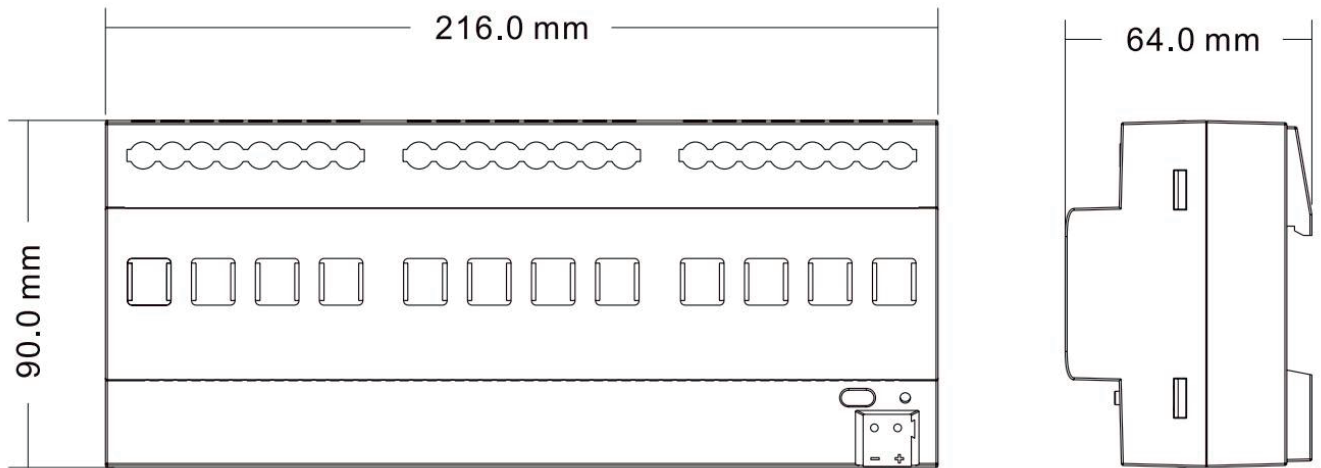

KNX-7123-82-DRO-DIN

3.2. Connection Diagram

3.2.1. KNX-7043-82-DRO-DIN

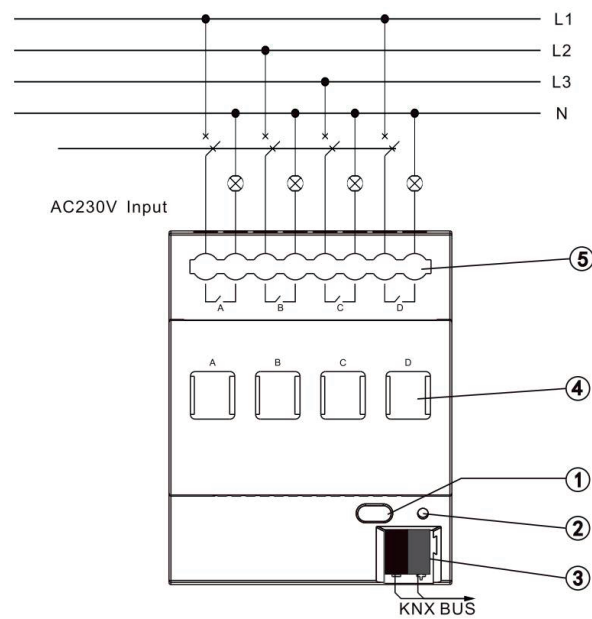

3.2.2. KNX-7123-82-DRO-DIN

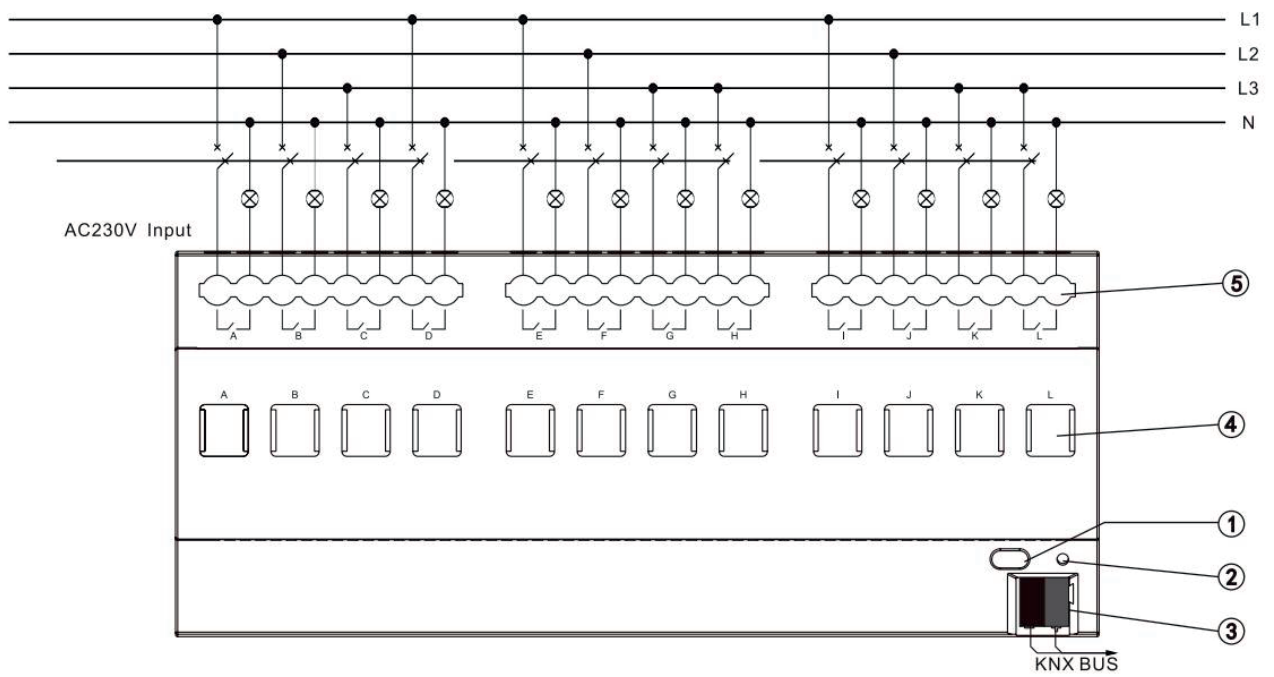

- ① Programming button
- ② Red LED for entering the physical address, Green LED flashing for application layer running normally
- ③ KNX bus connection terminal
- ④ Manual operation switch control
- ⑤ Output, load terminal

Reset the device to the factory configuration: press the programming button and hold for 4 seconds then release, repeat the operation for 4 times, and the interval between each operation is less than 3 seconds

Chapter 4. Parameters Setting Description in the ETS

4.1. KNX Secure

Switch Actuator with Secure is a KNX device that complies with the KNX secure standard. That is, you can run the device in safe way.

The device with KNX secure will be displayed notes on ETS, as shown as Fig.4.1(1).

If secure commissioning is activated in ETS project, the following information must be considered during device debugging:

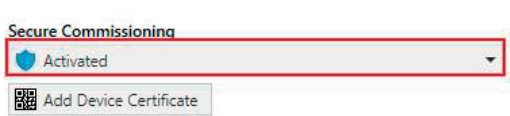

It is essential to assign a project password as soon as a KNX Secure device is imported into a project. This will protect the project against unauthorized access.

The password must be kept in a safe place – access to the project is not possible without it (not even the KNX Association or device manufacturer will be able to access it)!

Without the project password, the commissioning key will not be able to be imported.

A commissioning key is required when commissioning a KNX Secure device (first download). This key (FDSK = Factory Default Setup Key) is included on a sticker on the side of the device, and it must be imported into the ETS prior to the first download:

On the first download of the device, a window pops up in the ETS to prompt the user to enter the key, as shown in Fig.4.1 (2) below.

The certificate can also be read from the device using a QR scanner (recommended).

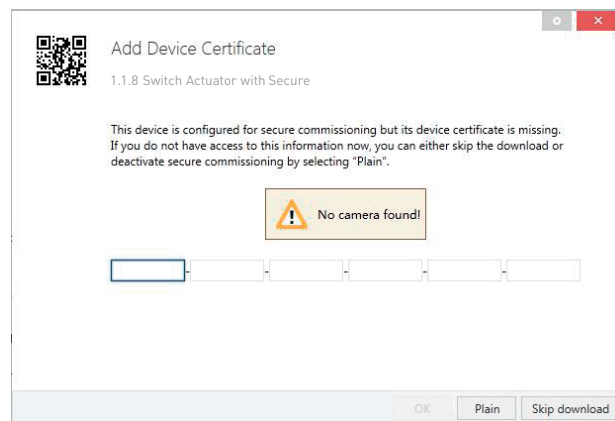

Fig.4.1(1) Add Device Certificate window

Alternatively, the certificates of all Secure devices can be entered in the ETS beforehand.

This is done on the "Security" tab on the project overview page, as shown in Fig.4.1(3) below.

The certificates can be also added to the selected device in the project, as shown in Fig.4.1(4).

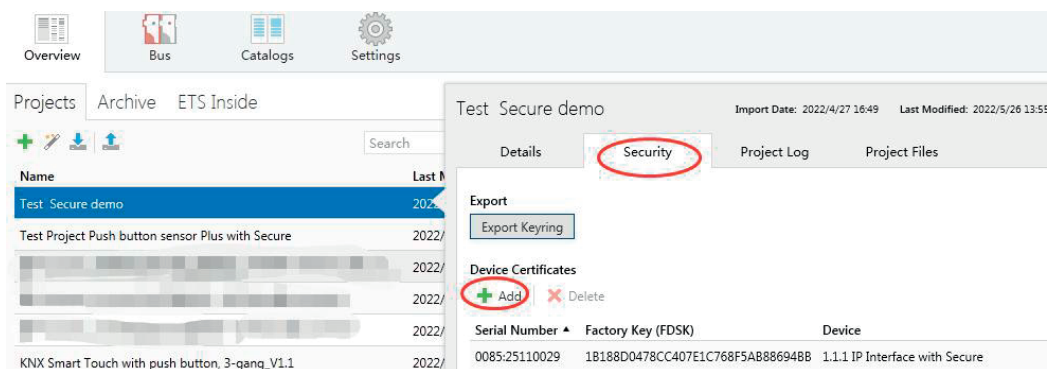

Fig.4.1(2) Add Device Certificate

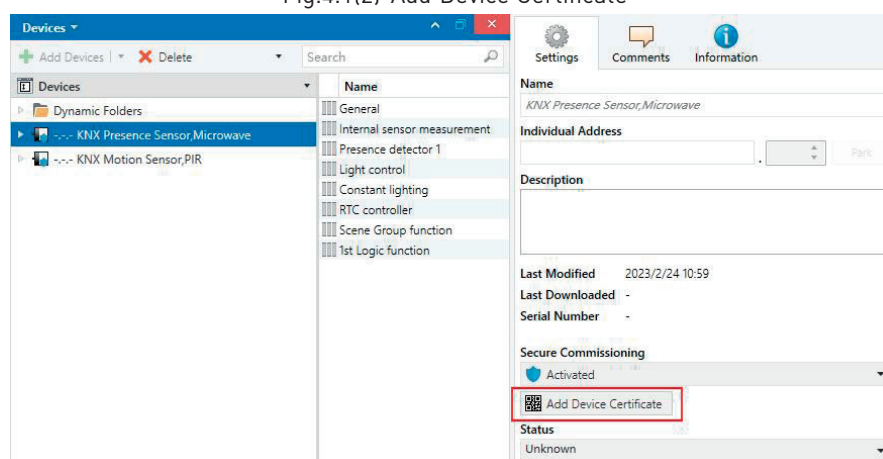

Fig.4.1(3) Add Device Certificate

There is a FDSK sticker on the device, which is used for viewing FDSK number.

Without the FDSK, it will no longer be possible to operate the device in KNX Secure mode after a reset.

The FDSK is required only for initial commissioning. After entering the initial FDSK, the ETS will assign a new key, as shown in Fig.4.1(5) below.

The FDSK will be required again only if the device was reset to its factory settings (e.g. If the device is to be used in a different ETS project).

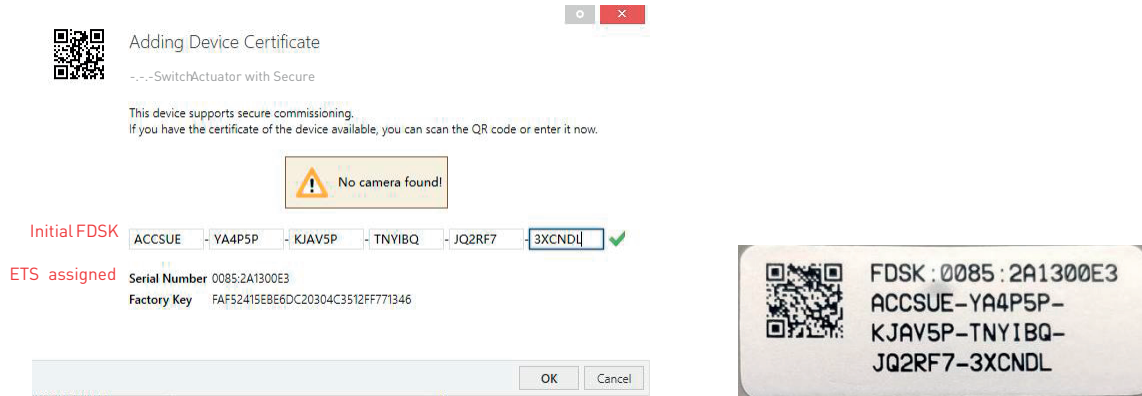

Fig.4.1(4)

Example:

If this application in the project needs to be tried with another device, it is no longer the original device. When the application is downloaded to a new device, the following prompt will appear on the left of Fig.4.1(6), click yes, the Add Device Certificate window will appear, then enter the initial FDSK of the new device, and you need to reset the device to the factory settings (it is not required if the device is still factory default; If it has been used, it will be required to reset, otherwise the following error message will appear on the right of Fig.4.1(6)), and then the device can be successfully downloaded again.

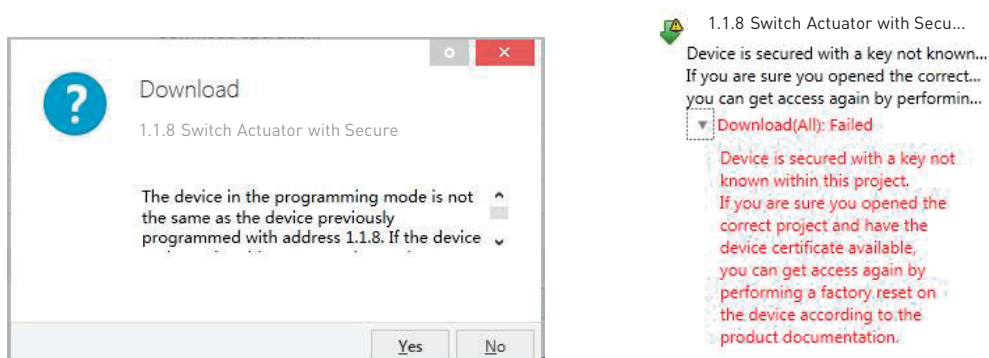

Fig.4.1(5) Example

Whether the device is replaced in the same project, or the device is replaced in a different project, the processing is similar: **Reset the device to the factory settings, then reassign the FDSK.**

After the device is downloaded successfully, the label Add Device Certificate turns gray, indicating that the key for this device has been assigned successfully, as shown in Fig.4.1(7) below.

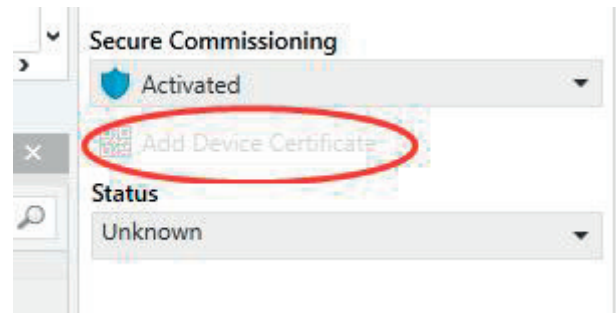

Fig.4.1(6)

ETS generates and manages keys:

Keys and passwords can be exported as needed to the use of security keys outside of the associated ETS projects. As shown in Fig.4.1(8) below, the file extension is .knxkeys.

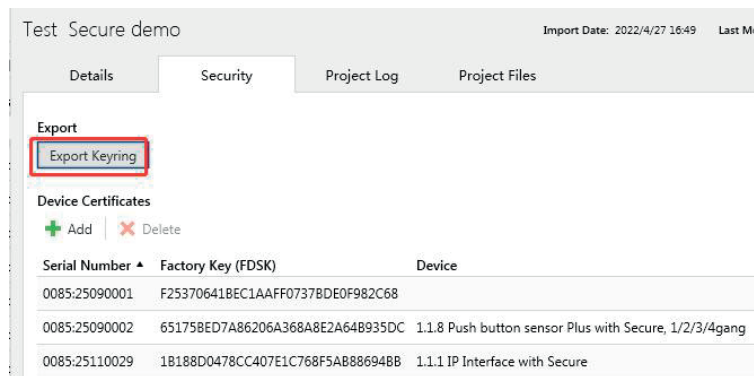
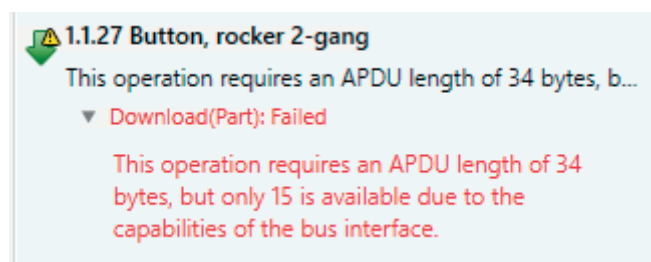

Fig.4.1(7)

Note: Any USB interface used for programming a KNX Secure device must support "longframes".

Otherwise ETS will report a download failure information, as shown below.



4.2. Parameter window “General”

The parameter window “General” will be shown in Fig. 4.2, here set product type and general parameters, general parameters apply to every output.

1.2.33 KNX Switch Actuators, 4 channel with KNX Secure > General

General	Product type	4-Fold Output
Channel A-...	Operation delay after bus recovery [10...250]	10 s
Channel B-...	Sending cycle of "In operation" telegram [1..240,0=inactive]	0 s
Channel C-...	Enable safety priority function	<input checked="" type="checkbox"/>
Channel D-...	Safety priority 1	Inactive
	Safety priority 2	Reset safety by object value "0"
	Control period of safety priority 2 [1..240,0=inactive]	0 s
	Priority of safety operation	Priority of 2 is higher than that of 1
	Normal, object value of switch on/off	"1"=switch on; "0"=switch off Switch on=contact close ; Switch off=contact open

Fig. 4.2 Parameter window “General”

Parameter “Product type”

The parameter sets the product type of the Switch Actuator with current detection, and selects the option according to the type of product actually used. Options:

4-Fold Output (apply to **KNX-7043-82-DRO-DIN**)

12-Fold output (apply to **KNX-7123-82-DRO-DIN**)

Parameter “Operation delay after bus recovery [10..250]”

The parameter determines the delay time to react after the bus voltage recovery (the delay time after electrified) to avoid the malfunction of the bus and 220V AC caused by the simultaneously working of various relays, excluding the initialization time (approx. 2 seconds) of the device.

Options: **10-250 s**

If there are other devices (e.g. monitor) require to read the communication target value of the relay during the delay time after power on, then this requirement will be recorded, and then reacted after the delay time is finished.

If the delay time is long enough, all contacts of the relay can work simultaneously.

NOTE: And considering that it will generate damage to the power system and bus if a lot of devices operate simultaneously after bus recovery , so it is suggested to set the different delay time to each device.

Parameter “Sending cycle of “Inoperation”telegram [1..240,0=inactive]”

The parameter determines the time interval to send the telegram which shows the actuator is working normally or not via the bus. With the setting “0”, the actuator doesn’t send the telegram; if the setting is not “0”, a telegram with the value “1” will be sent cyclically according to the setting to the bus.

Options: **0...240s, 0=cyclical send inactive**

It is suggested to select the maximum time interval according to the application to keep the bus load as low as possible.

NOTE: It is starting to count the time after power up, instead of the operation delay after recovery of bus voltage.

Parameter “EnableSafety priorityfunction”

The parameter is used to set the enable status of the function “Safety priority”.

If it is enabled, 2 “Safety priority” will be activated.

Parameter “Safety priorityx” (x = 1, 2)

There are 2 “safety priorities” for selecting. It is available to define the trigger condition to each “Safe priority”, and also enable the correspondent communication object “Safety Priorityx” (x=1, 2).

These objects are important to the entire relay when under the working mode “Switch Actuator” and “Heating actuator (without controller)”, but each output can react differently depending on the received telegrams, whose reactions can be defined in the parameter window “X: Safety”. Options:

Inactive

Reset safety by Object value “0”

Reset safety by Object value “1”

When the setting is “inactive”, it will not initiate any “Safety Priority”;

If the communication object “Safety Priority x” receives “0”, the “Control period” of “the Safety Priority x” will be initiated with “Reset safety by Object value “0””;

If the communication object “Safety Priority x” receives “1”, the “Control period” of “the Safety Priority x” will be initiated with “Reset safety by Object value “1””.

During the “Control period”, if the object “Safety Priority x” receives no corresponding telegram, it will trigger “Safety Priority”, and then the correspondent action will be initiated, which will be defined in the parameter window “X: Safety”.

Parameter “Control period of safety priority x [1..240, 0 = inactive]” (x = 1, 2)

This parameter is visible only if the parameter “safety priority x” (x = 1, 2) is activated. If no telegram is received from the object “Safety Priority x (x=1, 2)” during this time period (“Control period”), “Safety Priority x” is triggered.

When the object “Safety Priority x (x=1, 2)” is re-received, the “Safety Priority x” trigger is ended and the “Safety Priority x” timing (“Control period” is triggered) is reset. Options: **0... 240s**

If select “0”, the corresponding “Safety Priority x” is not activated. However, in this configuration, the object can be activated, i.e. the object receives the opposite message as the configured reset telegram value, triggering the corresponding security state. This does not apply if the setting is not 0s.

“Safety priority” function should be monitored longer than twice the sensor’s data-sending cycle to avoid an immediate alarm when individual signals occasionally fail.

Parameter “Priority of safety operation”

This parameter for describing that priority of 2 is higher than that of 1.

Parameter “Normal, object value of switch on/off”

This parameter for describing that the object value of Switch on/off.

“1”=switch on; “0”=switch off

Switch on=contact close ; Switch off=contact open

NOTE: “Switch on” mentioned below means the contact of the switch actuator is closed (output is on); “switch off” means the contact of the switch actuator is open (output is off)!

4.3. Overview of output

It is able to choose an operation mode and its corresponding functions for every output, and the functions are activated separately. The two operation mode and its corresponding functions are relative.

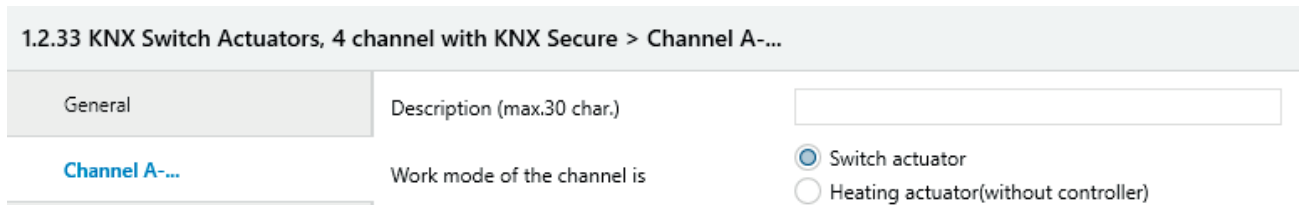

Fig.4.3 Parameter window "Channel X"

Parameter "Description (max. 30char.)"

This parameter is used to set the custom description of channel, up to input 30 characters.

Parameter "Workmode of the channel is"

This parameter is used to define the output mode. Options:

Switch actuator

Heating actuator(without controller)

Switch actuator

It is used for normal switching, for instance lighting control, which uses the object "Switch" to control the output directly. Lots of extension functions such as timing, logical, safety functions are available to use. Application description can be found in Chapter 4.4.

Heating actuator

In this function, the output is used to control the cooling/heating temperature. In some room, thermostat will send a control value out to switch the valve (e.g. 2-step control). Application description can be found in Chapter 4.5.

It works for all the outputs. "Channel X" mentioned below means any output of the switch actuator, which has the same parameter setup interface and communication objects. More details can be found below.

4.4. Parameter window “Channel X” Switch actuator

1.2.33 KNX Switch Actuators, 4 channel with KNX Secure > Channel A-...

General	Description (max.30 char.)	<input type="text"/>
- Channel A-...	Work mode of the channel is	<input checked="" type="radio"/> Switch actuator <input type="radio"/> Heating actuator(without controller)
A:Function	If bus recovery,output status is	Unchange ▼
Channel B-...	If bus failure,output status is	Unchange ▼
Channel C-...	Obj. value of "switch" after bus recovery	<input checked="" type="radio"/> To write with "0" <input type="radio"/> To write with "1"
Channel D-...	Set the reply mode of switch status	Transmit after change ▼
	Object value of switch status	<input type="radio"/> 0=contact close ; 1=contact open <input checked="" type="radio"/> 0=contact open ; 1=contact close
	Output status for the telegram "1" (telegram "0" is opposite of selection)	<input type="radio"/> Contact open <input checked="" type="radio"/> Contact close
	Extension function	<input checked="" type="checkbox"/>

Fig. 4.4(1) Parameter window “ChannelX” – Switch actuator

Parameter “If bus recovery,output status is”

The output can adopt a defined status on bus voltage recovery via this parameter. Options:

- Unchange**
- Contact open**
- Contact close**
- As before bus failure**

When selecting “Unchange”, the contact of the relay will remain the same as the last status before power off;

When selecting “**Contact open**”, contact of the channel will be opened when the bus power on;

When selecting “**Contact close**”, contact of the channel will be closed when the bus power on;

When selecting “**As before bus failure**”, contact position after voltage recovery is the same as that before power on.

NOTE: After finished application programming,all output channels will remain the same status.

Parameter “If bus failure,outputstatus is”

The output can adopt a defined status after the bus voltage failure via this parameter. Options:

Unchange

Contact open

Contact close

When selecting “Unchange”, status of contact will remain the same as the last status before power off;

When selecting “Contact open”, contact of the channel will be opened when the bus power off;

When selecting “Contact close”, contact of the channel will be closed when the bus power off.

Parameter “Obj. value of “switch” after bus recovery”

This parameter will be visible when enabling the logic function “Input 0” to define the default value of the communication object “Switch” after bus voltage recovery, which can be “0” or “1”. Options:

To write with “0”

To write with “1”

After application programming or bus recovery, the object value is 0.

Parameter “Set the reply mode of switch status”

This parameter defines the status of the current switch status when the telegram is sent. Options:

No reply

Respond after read only

Transmit after change

If selecting “No reply”, delay will not send any telegram;

If selecting “Respond after read only”, the status telegram will not be sent out until receiving the status telegrams from other devices;

If selecting “Transmit after change”, it will send the status automatically when there is any changes on the output.

The value ("0" or "1") of the communication object "Reply the switch status" and "Send the switch status" defines the current status of the relay, which can be set in the parameter "Object value of switch status" (when selecting "Respond after read only" or "Transmit after change").

Parameter "Object value of switch status"

This parameter will be visible when selecting "Respond after read only" or "Transmit after change" in "Set the reply mode of switch status". Options:

0=contact close ; 1=contact open

0=contact open ; 1=contact close

It means the contact of the relay will be closed when the value of the communication object "Reply the switch status" and "Send the switch status" is 0 when setting "0=contact close; 1=contact open", while it is open when the value is "1". It means the opposite with setting "0=contact open; 1=contact close".

Parameter "Output status for the telegram"1"(telegram"0" is opposite of selection)"

This parameter sets the position of the channel contact when the Switch object telegram"1" is received. The switch operation is triggered by the communication object "switch".. When enabling "Input 0" in the logic function, it will use the communication object "Switch," to modify the value of "Input 0", rather than triggering the switch operation. Options:

Contact open

Contact close

The contact position will be off with "**Contact open**", and on with "**Contact close**".

If the switch object message "0" is received, it is the opposite of what is selected by this parameter option.

NOTE: The parameter only works after receiving object "Switch", and defines the direction of the contact after receiving it.

Parameter “Extension function”

This parameter defines whether enable the extension functions of the switch actuator. The parameter window “X: Function” will be seen when it is enabled, and able to set the special functions individually in Fig. 4.4(2).

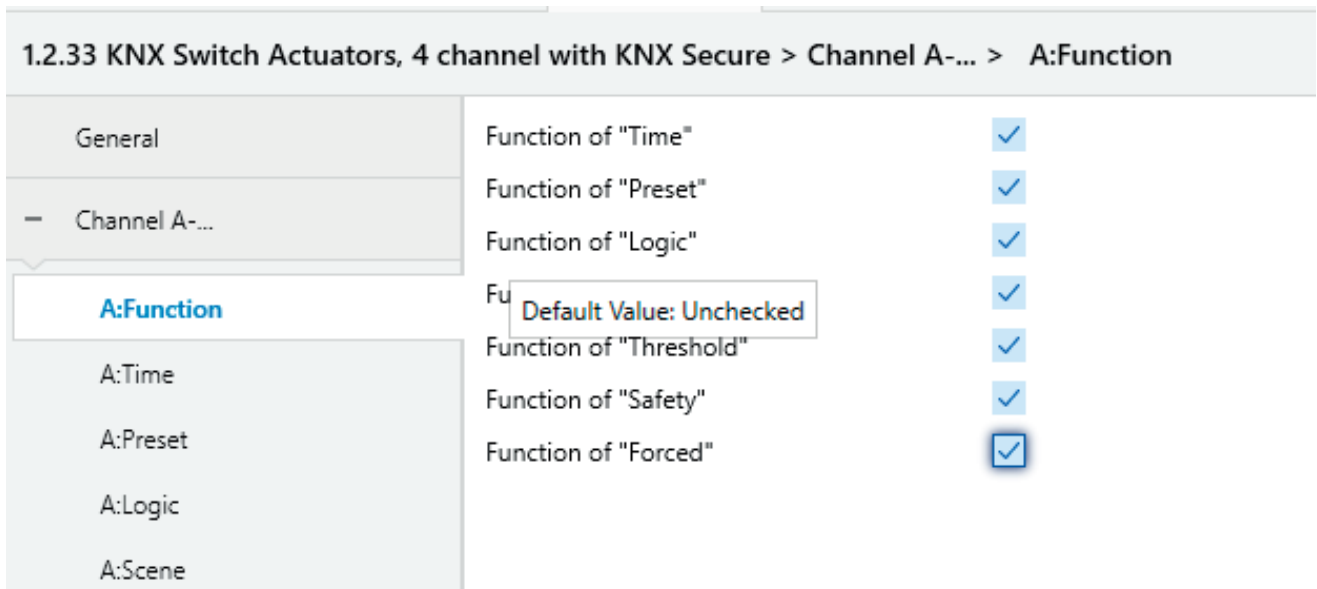

Fig. 4.4(2) Starting parameter window “X: Function”

4.4.1. Parameter window “X: Time”

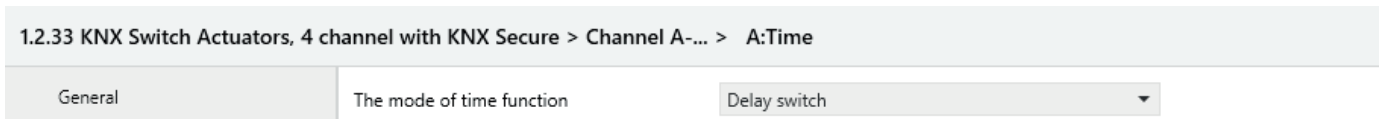

Fig. 4.4.1 Parameter window “X: Time”

This parameter window will become visible when the parameter “Function of ‘time’ for switch” is enabled in the parameter window “X:Function”. See Fig. 4.4.1 which is used to enable/disable the time function via bus.

Parameter “The Mode Of Time function”

The parameter defines the type of the timing function setup. Options:

- Delay switch**
- Flashing switch**
- Staircase lighting**

4.4.1.1 Selection “Delay switch”

The parameter window of the time function in Fig. 4.4.1.1 will be shown when selecting “Delay switch”.

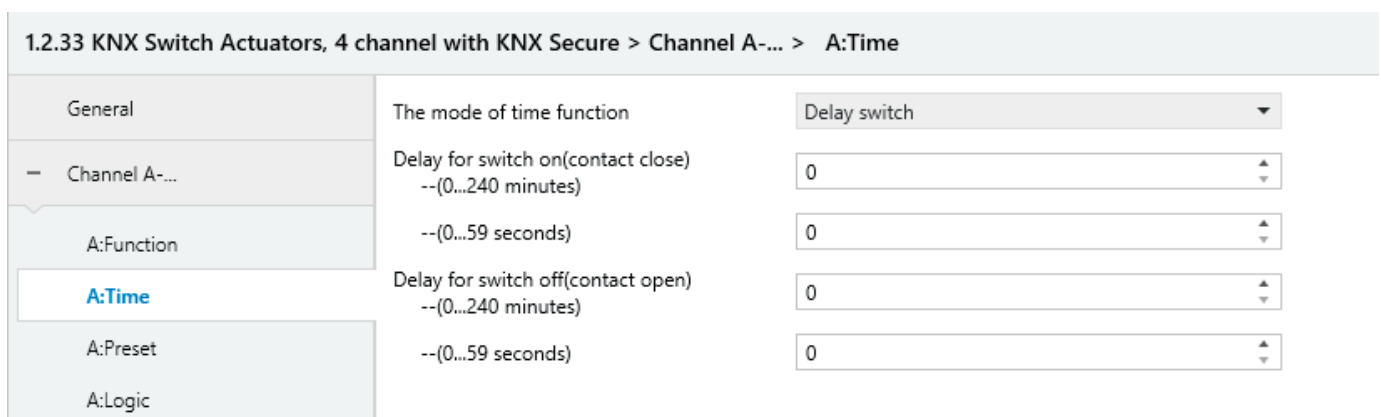

Fig. 4.4.1.1 Parameter window “X: Time”-Delay

Parameter “Delay for switching on(contact close): --(0...240 minutes) / -- (0...59 seconds)”

This parameter defines the delay time of the switch on (contact close). Options:

0..240 min

0..59 s

Setting the delay time to switch off when object receive the control telegram.

Parameter “Delay for switching off(contact open): --(0...240 minutes) / -- (0...59 seconds)”

This parameter defines the delay time of the switch off. (contact open). Options:

0..240 min

0..59 s

During the delay period, if the same packet command is received, the time is reset.

4.4.1.2 Selection “Flashing switch”

The parameter window in Fig. 4.4.1.2 will be shown up when selecting “Flashing switch” in “The mode of time function”.

1.2.33 KNX Switch Actuators, 4 channel with KNX Secure > Channel A-... > A:Time		
General	The mode of time function	Flashing switch
Channel A-...	Duration of switch on(contact colose) --(0...240 minutes)	0
A:Function	--(0...59 seconds)	0
A:Time	Duration of switch off(contact open) --(0...240 minutes)	0
A:Preset	--(0...59 seconds)	0
A:Logic	Number of ON-impulses [1..255,0=no limited]	0
A:Scene	Output status after flashing	Unchange
A:Threshold	Control mode of flashing	Start with "1" , Stop with "0"
A:Safety		

Fig. 4.4.1.2 Parameter window “X: Time”-Flashing switch

When the flashing function is activated, when the corresponding message is received, the system will start the flashing output. The blink switch interval can be set in the parameters "Duration of switch on(contact close): --(0...240 minutes)/--(0...59 seconds)" and "Duration of switch off(contact open): --(0...240 minutes)/--(0...59 seconds)". It will restart the flashing when receiving the relevant telegram by the object "Switch out with flashing", and define the contact position after flashing.

Parameter "Duration of switch on(contact close): --(0...240 minutes) / -- (0...59 seconds)"

This parameter defines the duration time to switch on(contact close) the output when flashing.

Options:

0..240 min

0..59 s

Parameter "Duration of switch off(contact open): --(0...240 minutes) / -- (0...59 seconds)"

This parameter defines the duration time to switch off (contact open) the output when flashing.

Options:

0...240 min

0...59 s

NOTE: it will not be executed unless the time is lower than the relay threshold switch frequency.

Since there will be not sufficient energy to do it because of the frequent relay switching, and it may cause time delay. The same situation will happen after the bus voltage recovery.

Parameter "Number of ON-impulses [1...255, 0=no limited]"

This parameter setting the flashing times. A flashing includes an on and an off Options: **0...255**

NOTE: 0 means no limited!

Parameter "Output status after flashing"

This parameter points out the relay contact position after flashing. Options:

Unchange

Contact open

Contact close

Parameter “Controlmode of flashing”

The parameter states the mode of the flashing output. Options:

Start with “1”, stop with “0”

Start with “0”, stop with “1”

Start with “1/0”, can not be stopped

It will start flashing with “1” received by the object “Switch out with flashing” when selecting “Star with ‘1’, stop with ‘0’”; it will stop flashing with “0”.

It will start flashing with “0” received by the object “Switch out with flashing” when selecting “Star with ‘0’, stop with ‘1’”; it will stop flashing with “1”.

It will start flashing with either “1” or “0” received by the object “Switch out with flashing” when selecting “Star with ‘1/0’, cannot be stopped”; Under this circumstance it cannot terminate the flashing by sending the telegram until the preset ending time, unless it is blocked by other operation or wait for execution finish.

4.4.1.3 Selection “Staircase lighting”

The parameter window of the staircase lighting function in Fig. 4.4.1.3 will be visible when selecting “Staircase lighting” in the parameter “The mode of time function”.

1.2.33 KNX Switch Actuators, 4 channel with KNX Secure > Channel A-... > A:Time		
General	The mode of time function	Staircase lighting
Channel A-...	Duration of staircase lighting --(0...1000 minutes)	2
A:Function	--(0...59 seconds)	0
A:Time	Control mode of staircase lighting	Start with "0/1", can not be stop
A:Preset	During the lighting time, if receive the "Start" telegram	<input checked="" type="radio"/> Restart duration of staircase lighting <input type="radio"/> Ignored the "start" telegram
A:Logic	Warning mode for ending of staircase lighting	Nothing
A:Scene	Modify the duration via object[0..60059s]	<input checked="" type="checkbox"/>
A:Threshold		

Fig. 4.4.1.3 Parameter window “X: Time” Staircase lighting

The staircase lighting function is switched on via the object “Output of staircase lighting”. And also it is available to program the value of “Output of staircase lighting”. The staircase lighting time starts when it is switched on and will be switched off immediately after the set time when there is no prewarning setting.

Parameter “Duration of staircase lighting-(0...1000 minutes) / --(0...59 seconds)”

This parameter describes the duration time when switching on the staircase light function: minutes. Options:

0...1000 min

0...59 s

NOTE: If the minute is set to “0”, and the seconds is set to “0”, the staircase lighting will be disabled.

Parameter “Controlmode of Staircase lighting”

This parameter defines the mode of the staircase lighting function. Options:

Start with “1”, OFF with “0”

Start with “1”, no action with “0”

Start with “0/1”, cannot be stopped

When selecting “Start with “1”, OFF with “0””, it will switch on the staircase lights with the value “1” received by the object “Output of staircase lighting”; it will switch off on by the value “0”.

When selecting “Start with “1”, no action with “0””, it will switch on the staircase lights with the value “1” received by the object “Output of staircase lighting” and no reaction with “0”.

When selecting “Start with “0/1”, cannot be stopped”, it will switch on the staircase lights either with “0” or “1” received by the object “Output of staircase lighting” but cannot end it by the object until the duration time finished or changed by other operation.

Parameter “During the lighting time, if receive the ‘start’ telegram”

Options:

Restart duration of staircase lighting

Ignored the “start” telegram

It will restart the staircase lights to redo the timing if receive the telegram of the object “Output of staircase lighting” when selecting “restart duration of staircase lighting” during the staircase lighting; while it will ignore the telegram with “Ignored the ‘start’ telegram”.

Parameter “Warning mode for ending of staircase lighting”

The parameter points out the alarm type when terminating the staircase lights, which will start the prewarning notice before switching off. This prewarning time is included in the starting duration of the staircase. There will be no alarm if selecting “Nothing”, as well as the lights is off before the prewarning time. Options:

Nothing

Via object

Flashing the channel output with OFF/ON

Via object & flashing the channel output

2 types of prewarning are provided:

--Via the communication object: set the value of the object “Warning of staircase” as “1” when starting alarming and then send it to the bus;

--Via the output flashing: control the output flashing (a short switch), and the duration is 1 second.

These 2 types can be used independently or together. It will be the type of “by the communication object” when it is “via object”, or the type of “by the lights flashing” with “flashing the channel output with OFF/ON”; as well as mixed type with “via object & flashing the channel output”.

--Parameter “The warning time for ending of staircase lighting 0..59”

The parameter is visible after selecting a prewarning type, and the duration of the prewarning: second.

Options: **0..59 s**

Parameter “Modify the duration via object [0..60059s]”

It will activate the object “Duration of staircase” with 2 bytes when it is enabled to modify the staircase lighting time, however it cannot modify the time if disabled.

NOTE: If the values of telegram for modification the duration is “0”, the staircase lighting will be disabled.

4.4.2. Parameter window “X: Preset”

This parameter window as shown in Fig. 4.4.2 when the parameter “Function of ‘preset’ for switch” is enabled in the parameter window “X: Function”.

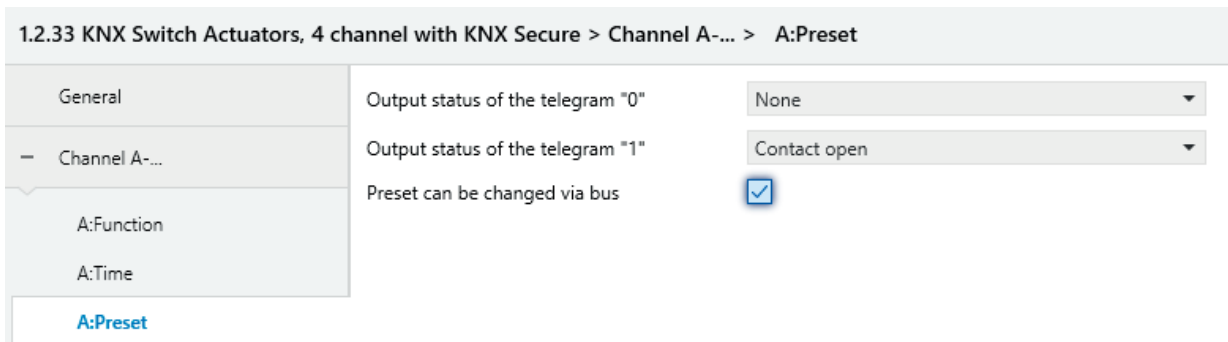

Fig. 4.4.2 Parameter window “X: Preset”

It is able to not only recall the preset value, but also save the new value of the current switch status by the bus.

There are 2 objects to recall and save the preset value, and 2 optional preset values (telegram “0” and telegram “1”). It means “telegram “0”” with “0”, and “telegram “1”” with “1”.

Parameter “Output status of the telegram “0””

This parameter defines the relay status when recalling the preset value “telegram “0” ” (that is when the object “Recall preset” receives the telegram “0”) by setting the communication object “Recall preset”. Options:

- None**
- Contact close**
- Contact open**

Parameter “Output status of the telegram “1””

This parameter defines the relay status when recalling the preset value “telegram “1” ” (that is when the object “Recall preset” receives the telegram “1”) by setting the communication object “Recall preset”. Options:

- Contact open**
- Contact close**
- Last position of contact**
- Same as the telegram “0”**

When the action triggered by telegram "1" selects "last position of contact", it will be recovered to the last switch status every time recalling telegram "1".

When the action triggered by telegram "1" selects "Same as the telegram "0"", it will carry out the set parameters of the action triggered by telegram "0" every time recalling telegram "1".

Parameter "Preset can be changed via bus"

It is used to set whether changing the preset value by the bus. It is allowable to change the value and enable the object "Store preset" at the same time when enabled, which can save the current status as the new preset value.

The current value is saved as new telegram "0" when receiving the telegram "0"; as new telegram "1" when "1".

The current status will be saved in the new preset value if selecting "None" in "Output status of the telegram "0"" and "Last position of contact" or "Same as the telegram "0"" in "output status of the telegram "1" (object value=1)".

Note: It will save the new preset value after bus voltage recovery.

4.4.3. Parameterwindow “X: Logic”

It will show up Fig. 4.4.3 when “Function of ‘logic’ for switch” is enabled in Fig. 4.4(2) .

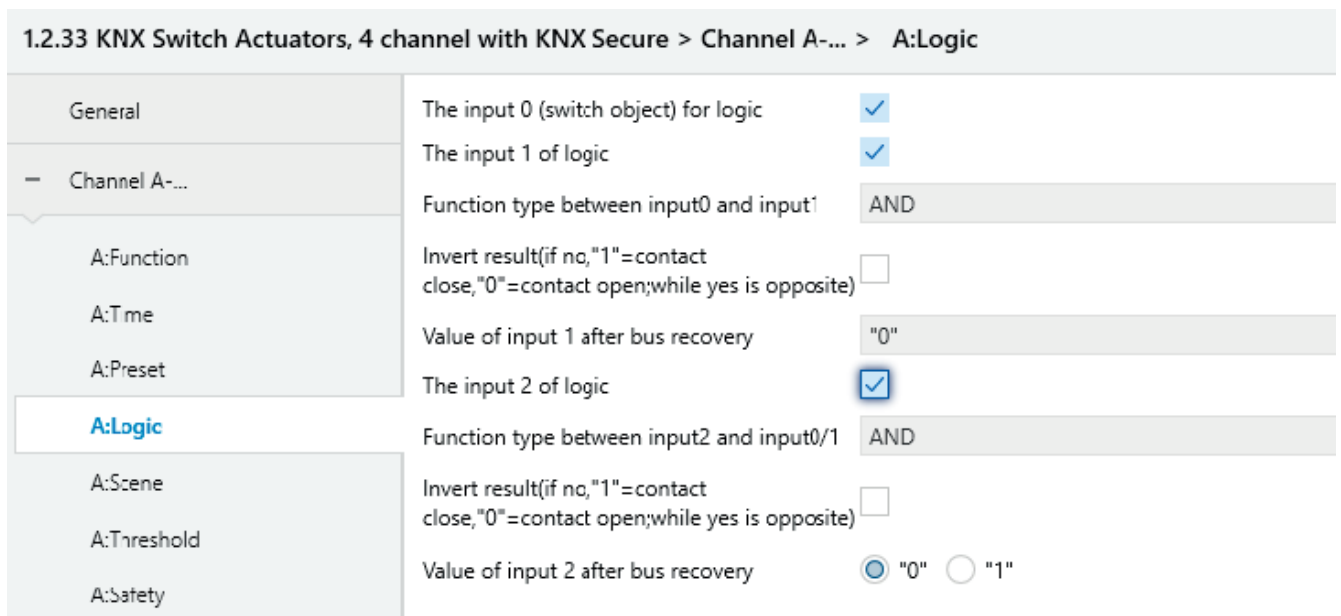

Fig. 4.4.3 Parameterwindow “X: Logic”

There are 2 logic communication objects to decide the status of individual output, which are related to the “Switch”.

It will re-operate when receiving a new object value as the final output status (close the contact with “1”, open it with “0”).

The value of the communication object “Input 1 of logic” is logically operated with “Switch,X” firstly, and then the result is logically operated with the value of “Input 2 of logic”. This operation will ignore the object which are disabled, and continue to the next step with the enabled objects.

Parameter “The input 0 (switch object) for logic is”

This parameter is used to enable the function of logic operation of “Input 0”, whose values are written by the object “Switch”.

Parameter “The input x of Logical” (x = 1, 2)”

This parameter describes the status of the logic operation of the object “Input 1 of logic” or “Input 2 of logic”.

Parameter “Function type between input 0 and input 1

Parameter “Function type between input 0 and input input 2 and input 0/1”

These two parameters introduce the logical relationship of the logic operation, providing 3 standard logical operations (AND, OR, XOR) and a GATE function.

Explanation for GATE function: Gate function is equivalent to a door, if the door is open, then the previous logic result will can be output, if it is closed, there will be no influence to output. For example, the logic input 2 sets to Gate function and logic value 1, then the logic result of input 0 and input 1 can be output, if logic value of the input 2 is 0, the output will keep. Options:

AND

OR

XOR

GATE

Below result of logic operation is possible:

Logic function	Object values					Description
	Input0(Switch)	Input1	Result of Input 0/1	Input2	Output	
AND	0	0	0	0	0	The result is 1 if both input values are 1.
	0	1	0	1	0	
	1	0	0	0	0	
	1	1	1	1	1	
OR	0	0	0	0	0	The result is 1 if one of both input values is 1
	0	1	1	1	1	
	1	0	1	0	1	
	1	1	1	1	1	
XOR	0	0	0	0	0	The result is 1 if both input values have a different value.
	0	1	1	1	0	
	1	0	1	0	1	
	1	1	0	1	1	
GATE	0	Closed	0	Closed	0	The input 0 of value is only allowed through if the GATE (input 1 and input 2) is open. Otherwise the input0 of value is ignored.
	0	Open		Open		
	1	Closed	1	Closed	1	
	1	Open		Open		

Note:

1. The value of the communication object "Input 1" **is logically operated** with "Switch" firstly, and then the result will be logically with the value of "Input 2", and the final operation result as the final output (close the contact with "1", open it with "0").

2. If an input is not enabled, the input is ignored.

3. If logical result needs to be negated, the first negated, then the next step.

4. The signal can be passed if the GATE is open, otherwise it is ignored. For example, the input 0 of value is ignored when the GATE of input 1 is closed, and the output is directly determined by the input 2.

Parameter "Invert result (if no, "1"=contact close, "0"=contact open; while yes is opposite)"

This parameter defines whether negate the logical operation results. Negate it when it is enabled, otherwise don't take to invert.

Parameter "Value of input 1 after bus recovery"

This parameter defines the default value of the object "Input 1 of logic" after bus voltage recovery.

Options:

"0"

"1"

Value before power off

The value will be the one before power off after bus voltage recovery when selecting "value before power off". After application programming, the object value is 0.

Parameter "Value of input 2 after bus recovery"

This parameter defines the default value of the object "Input 2 of logic" after bus voltage recovery.

Options:

"0"

"1"

4.4.4. Parameterwindow “X: Scene”

The parameter window shown in Fig. 4.4.4 will burst out when “Function of ‘scene’ for switch” is enabled in Fig. 4.4.(2) .

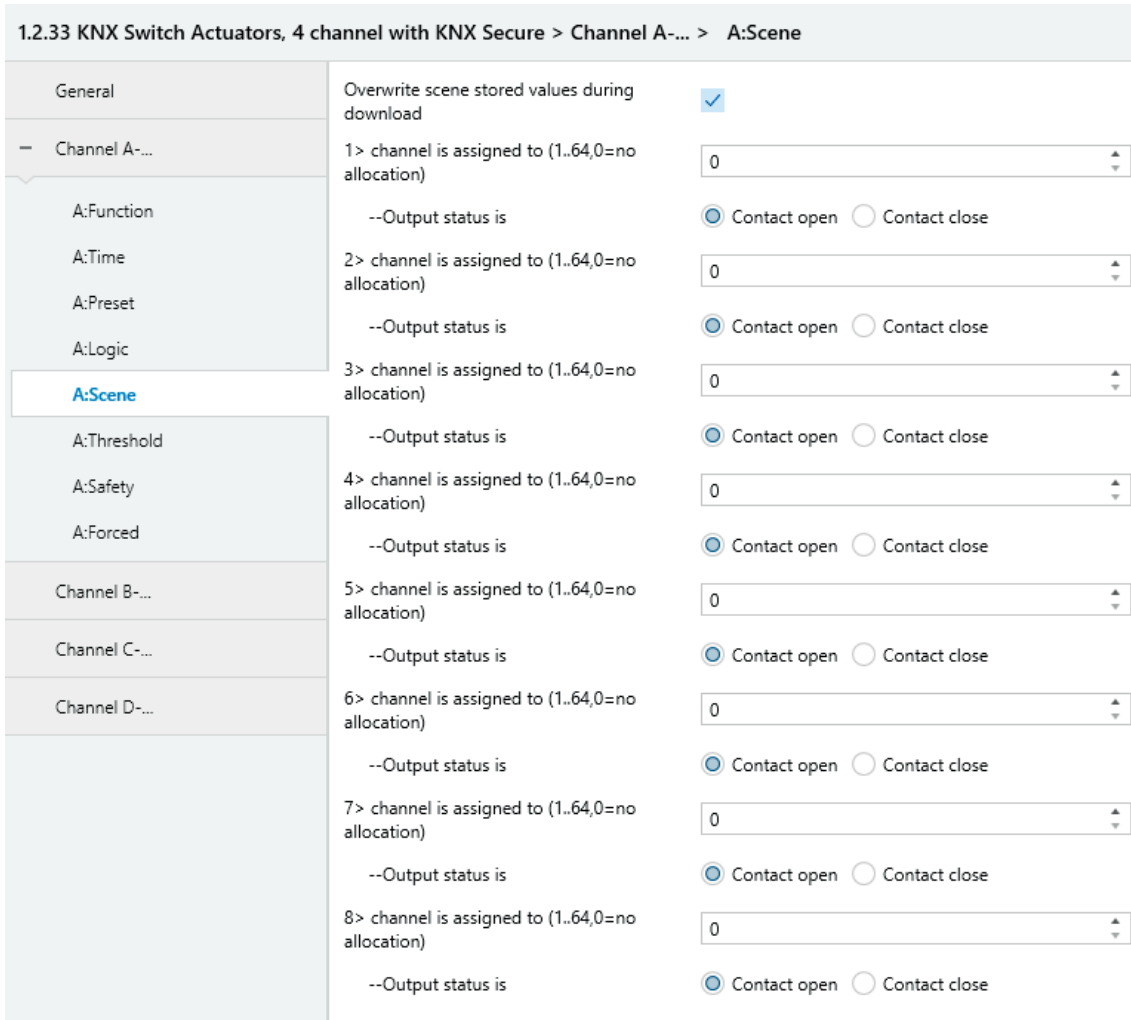

1.2.33 KNX Switch Actuators, 4 channel with KNX Secure > Channel A-... > A:Scene		
General	Overwrite scene stored values during download	<input checked="" type="checkbox"/>
Channel A-...	1> channel is assigned to (1..64,0=no allocation)	0
A:Function	--Output status is	<input checked="" type="radio"/> Contact open <input type="radio"/> Contact close
A:Time	2> channel is assigned to (1..64,0=no allocation)	0
A:Preset	--Output status is	<input checked="" type="radio"/> Contact open <input type="radio"/> Contact close
A:Logic	3> channel is assigned to (1..64,0=no allocation)	0
A:Scene	--Output status is	<input checked="" type="radio"/> Contact open <input type="radio"/> Contact close
A:Threshold	4> channel is assigned to (1..64,0=no allocation)	0
A:Safety	--Output status is	<input checked="" type="radio"/> Contact open <input type="radio"/> Contact close
A:Forced	5> channel is assigned to (1..64,0=no allocation)	0
Channel B-...	--Output status is	<input checked="" type="radio"/> Contact open <input type="radio"/> Contact close
Channel C-...	6> channel is assigned to (1..64,0=no allocation)	0
Channel D-...	--Output status is	<input checked="" type="radio"/> Contact open <input type="radio"/> Contact close
	7> channel is assigned to (1..64,0=no allocation)	0
	--Output status is	<input checked="" type="radio"/> Contact open <input type="radio"/> Contact close
	8> channel is assigned to (1..64,0=no allocation)	0
	--Output status is	<input checked="" type="radio"/> Contact open <input type="radio"/> Contact close

Fig. 4.4.4 Parameterwindow “X: Scene”

Parameter “Overwritescene stored values during download”

This parameter sets whether to override the scene save value during application download.

If it is disabled, the stored values before the download can be not overwritten by the parameterized scene value. When the scene is called, the scene saved before the download is still enabled until it is replaced by the new storage scene.

If it is enabled, the stored values will be overwritten by the parameterized scene value during the download. When the scene is called, the scene will be set according to the parameters until it is replaced by the new storage scene.

Parameter “x>channel is assigned to (1...64 scene NO., 0=no allocation)”(x=1~8)

It is able to allocate 64 different scene numbers to every output. There are 5 various scenes can be set per output. Options: **1... 64, 0=no allocation**

Note: the valid scene numbers in the parameter setting options are 1-64. The actual corresponding telegram is 0..63. If a scene is stored via a learning telegram, the new scene will be active immediately and still be valid even if power failure.

Parameter “--Output status is:”

This parameter defines the switch output status when recalling the scene. Options:

Contact open
Contact close

4.4.5. Parameter window “X: Threshold”

The window in Fig. 4.4.5 will be shown up when the parameter “Function of ‘threshold’ for switch” is enabled in Fig. 4.4(2) .

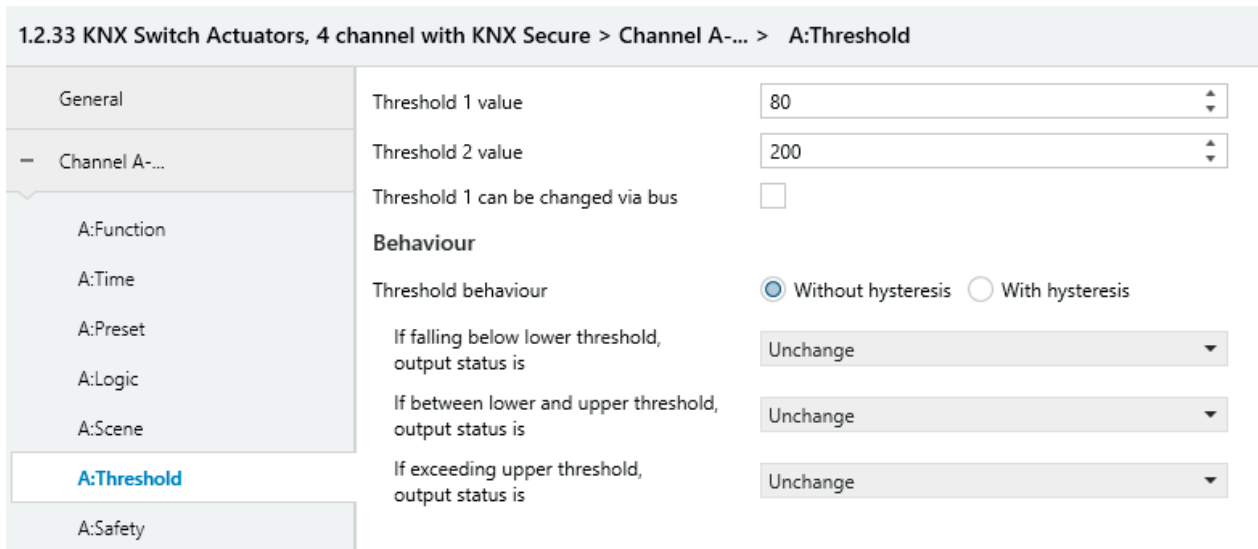

Fig. 4.4.5 Parameter window “X: Threshold”

The object “Threshold input” of 1Byte is enabled when activating the threshold function.

It will trigger the switch to make one operation if the value of the object “Threshold input” is lower or more than the default threshold.

There are 2 individual thresholds are ready to use always and the “Threshold 1 value” is set by the bus.

Parameter “Threshold 1 value”

Parameter “Threshold 2 value”

These two parameters define the value of threshold 1 and threshold 2. Options: **0...255**

It must to meet the condition Threshold 1<Threshold 2, if not, you can not configure in ETS:



Parameter “Threshold 1 can be changed via bus”

This parameter defines whether change the threshold value by bus or not.

It is able to start the object “Change Threshold value 1” when enabled, and change the threshold 1 value by the bus; on the other hand, it cannot change the value when disabled.

However it is not allowable to change the “Threshold 2 value” by the bus.

Parameter “Threshold behaviour”

The parameter defines the hysteresis status of “threshold 1 value” and “threshold 2 value”. Option:

Without hysteresis

With hysteresis

The hysteresis can avoid the unnecessary behaviour caused by the input value if its value is between two threshold values.

Parameter “If falling below lower threshold output status is”

Parameter “If between lower and upper output status is”

Parameter “If exceeding upper threshold output status is”

These parameters are used to define the relay action in the object “Threshold input”. Options:

Unchange

Contact open

Contact close

When it is “With hysteresis”, the parameter “If lower < object value < upper, contact position” is not visible and now the object is no action.

4.4.6. Parameter window “X: Safety”

The window shown in Fig.4.4.6 will be seen when the parameter “Function of ‘safety’ for switch” is enabled in Fig. 4.4(2) .

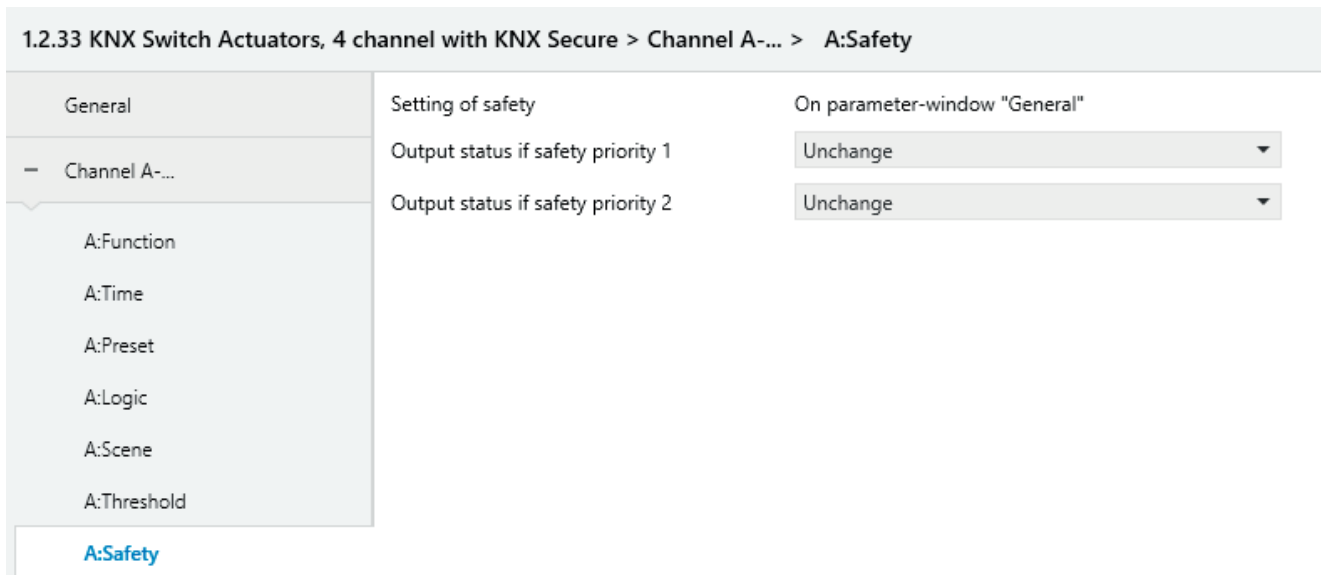

Fig. 4.4.6 Parameter window “X: Safety

Enable two “Safety Priority” (x=1, 2) in the parameter window “General”, which define the relay’s contact position for every output individually.

There are 2 safety priorities for every output and also the “Safety Priority 2” is prior to “Safety Priority 1”. It means when these 2 priorities are triggered at the same time, the contact position will follow the setup of “Safety Priority 2”.

Parameter “Output status if safety priorityx” (x=1, 2)

It defines the contact position after triggering “Safety Priorityx” (x=1, 2). Options:

Unchange

Contact open

Contact close

Unchange: the contact position is unchanged.

Contact open: the contact position is opened.

Contact close: the contact position is closed.

4.4.7. Parameter window “X: Forced”

The window of the function “forced” in Fig. 4.4.7 will be visible when the parameter “Function of ‘forced’ for switch” is enabled in Fig. 4.4(2) .

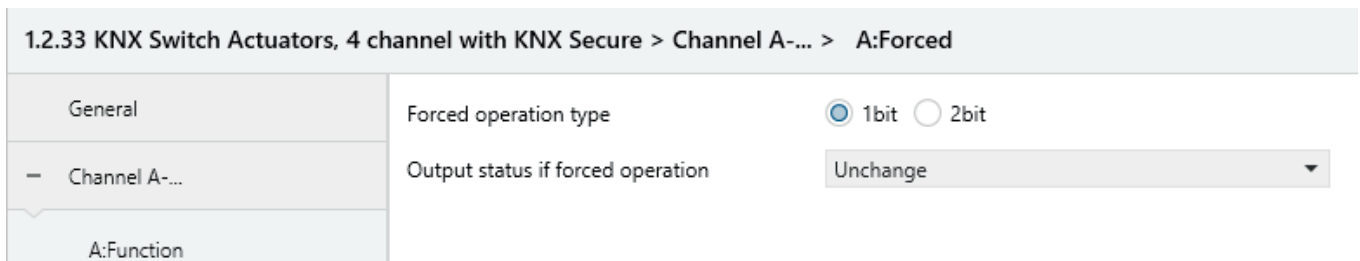

Fig. 4.4.7 Parameter window “X: Forced”

“Forced operation” will be used in some special situation such as emergency, and are activated by the object “Forced output” with the highest priority in the system, which means only “Forced operation” are valid in this case.

Parameter “Forced operation type”

This parameter defines the data type of the force operation. Options:

1bit

2bit

If selecting “2bit” when the object “Forced output” receives a telegram value, the action as follow:

Value of the object "Forcedoutput, X"	Action
00b (0) , 01b (1)	Cancel force operation, other operation can be performed
10b (2)	Force switch off (OFF)
11b (3)	Force switch on (ON)

When cancel the forced operation, the position of relay contact is unchanged. However, if time function(Delay/Flashing/Staircase) is running before forced operation, then time order will still continue during forced operation, if cancel the forced operation, time counting has not finished, it will continuously operate time function.

Parameter “output status if forced operation”

This parameter is visible if the option “1bit” is set via the above parameter, which defines the contact position of the “forced operation”. Options:

Unchange

Contact open

Contact close

Unchange: the contact position is unchanged.

Contact open: the contact position is opened.

Contact close: the contact position is closed.

Forced operations have the highest priority, and all other operations are ignored during forced operations. Controlling telegrams received during forced operation is ignored.

4.5. Parameter window “Channel X” Heating actuator

The window of “Channel X-Heating actuator” in Fig. 4.5(1) will be visible with “Heating actuator (without controller)” in “Work mode of the channel”.

In the running mode of “Heating actuator”, it is used to control heating valve or temperature sensor to realize the temperature constancy in the room.

There are 2 options of control mode for every output: 1 bit control and 1 byte control. Under the 1bit mode, it will receive 1 bit command by the communication object “On-off”; under the 1byte mode, it will receive 1 byte command by the communication object “Continuous control”.

“0” means the valve is off, while “100%” is on. And 0~100% means during a cycle period, the valve will be on for x% of the period while off for the rest time.

1.2.33 KNX Switch Actuators, 4 channel with KNX Secure > Channel A-...

General	Description (max.30 char.)	<input type="text"/>
- Channel A-...	Work mode of the channel is	<input type="radio"/> Switch actuator <input checked="" type="radio"/> Heating actuator(without controller)
A:Function	Valve type	<input checked="" type="radio"/> Normal (de-energised closed) <input type="radio"/> Inverted (de-energised open)
Channel B-...	If bus failure,output status is	Unchange ▼
Channel C-...	If bus recovery, valve position is	0%(OFF) ▼
Channel D-...	PWM cycle time for continuous control [1...240]	3 min
	PWM cycle time for continuous control [0...59]	0 s
	Control type	<input checked="" type="radio"/> 1 bit (on-off control) <input type="radio"/> 1 byte (continuous)
	Reply the status of contact state	Nothing ▼
	Extension function	<input checked="" type="checkbox"/>

Fig. 4.5(1) Parameter window “Channel:X-Heating actuator”

Parameter “Valve type”

This parameter sets the valve type for the connected valve. Options:

Normal (de-energised closed)

Inverted (de-energised open)

Normal (de-energised closed) : is applicable to normally closed valve.

Inverted (de-energised open) : is applicable to normally opened valve.

Parameter “If bus failure,outputstatus is”

This parameter defines the contact position when the bus power off. Options:

Unchange

Contact open

Contact close

Unchange: the contact position is unchanged when bus power off;

Contact open: the contact position is opened when bus power off;

Contact close: the contact position is closed when bus power off;

The above setting will be valid only when the power for relay drive is enough after the bus voltage off.

Parameter “If bus recovery, valve position is”

This parameter for setting the action of the valve switch when the bus recovers power supply, and the action lasts until receiving the control command or entering the failure mode. Options:

0%.(OFF)

10% (26)

...

100% (ON)

Example 20%, PWM cycle is 100s (1 minute 40s), then the cycle of valve opening and closing action will be 20s for opening and 80s for closing.

Parameter “PWM cycle time for continuous control [1...240]”

Parameter “PWM cycle time for continuous control [0...59]”

The period of pulse width control (PWM) is set here. This value is in minutes and seconds. Options:

1...240 min

0...59 s

Note: in order to prolong the service life of relay and controlled equipment, the pulse period shall be set as long as possible.

In the 1 bit control mode, pulse width control (PWM) is only used to control the action of the driver when the driver is in fault, forced operation mode, safe operation mode and bus voltage is restored.

Parameter “Control type”

The heating actuator can either be controlled via the 1 bit communication object Switch or the 1 byte communication object Control value (PWM). Options:

1 bit (on-off control)

1 byte (continuous)

In the control mode of “1bit”, the function of the heating actuator is as the same as the common switch actuator: the thermostatic room controller control the output by the common switch command. During a malfunction when the control signal is not received by the room thermostat, the relay will undertake an autonomous PWM calculation. PWM cycle time is used for this purpose.

In the control mode of “1 byte”, the sending value of the room thermostatic controller is from 0 to 255 (corresponding from 0% to 100%), which is so called “continuous-action control”. 0% means the valve is closed and at 100% fully open. It will adjust the output control via pulse width modulation.

Note: under the dynamic regulation function, each time the telegram of continuous regulation is received, the channel will recalculate the duty cycle of the pulse according to the new control value, when the time is up, and perform the action.

Parameter “Reply the status of channel for continuous control”

It is visible when selecting “1 byte (continuous)” in the parameter “Control type”, which is used to report the status of the controlled valve, with 2 options according to the type of the controlled devices: 1 bit and 1 Byte. Options:

Nothing

Yes, 0% = “0”, otherwise “1” (1 bit)

Yes, 0% = “1”, otherwise “0” (1 bit)

Yes, continuous control value (1 byte)

Parameter “Reply the status of contact state”

This parameter sets whether the device reply the switch state of the contact. Options:

Nothing

Yes, “1”=contact close, “0”=contact open

Yes, “0”=contact close, “1”=contact open

Under the selecting of “Yes, ‘1’=contact close, ‘0’=contact open”, when there is some request from other devices, the object “Reply status of contact” will send “1” to other devices if the contact is closed; While if it is open, it will send “0” to the other devices.

It is quite the contrary when selecting “Yes, ‘0’=contact close, ‘1’=contact open”.

Note: After programmed or system reset, if switch status is assure, object “Relay status of contact” will send status telegram to the bus: if it is not assure, status telegram will not be sent.

Parameter “Extension function”

This parameter defines whether enable the extension functions of the Heating actuator. The parameter window “X: Function” will be seen with “active”, seen in Fig. 4.5(2). And able to set the special functions individually.

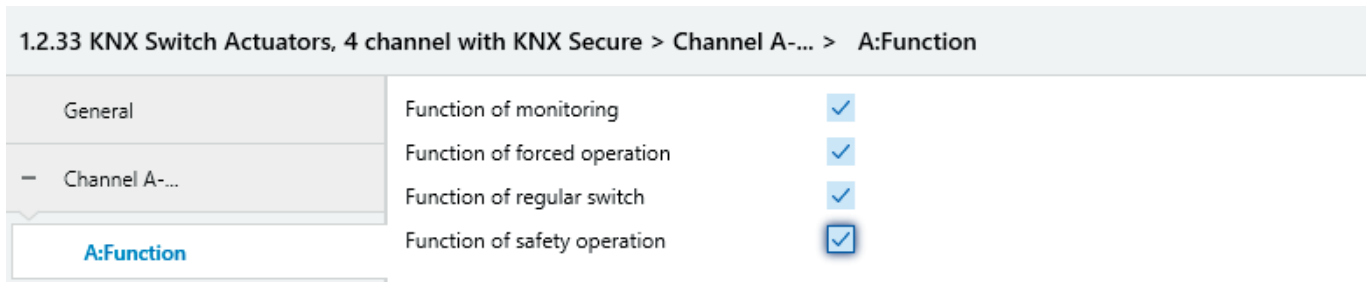
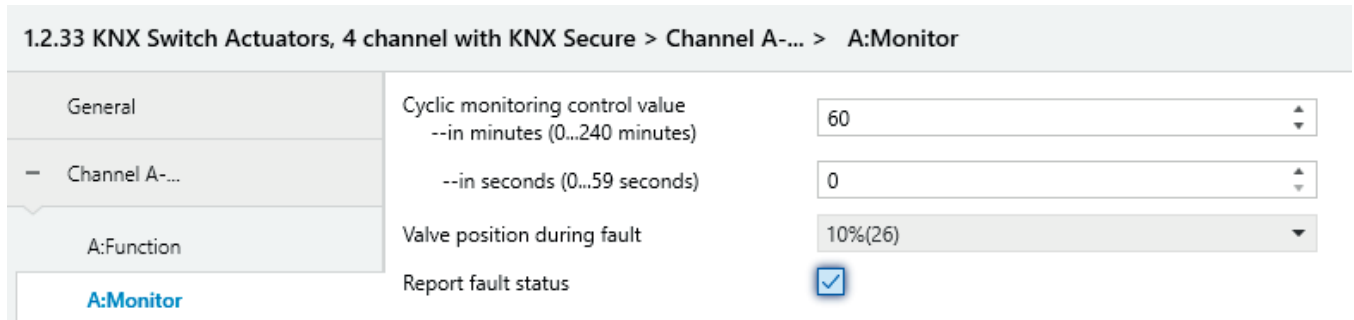

Fig. 4.5(2) Parameter window “X: Function”

4.5.1. Parameter window “X: Monitoring”

The monitor function in Fig. 4.5.1 “X: Monitoring” will be shown when it is enabled in the function “function for monitoring” in Fig. 4.5(2) .



1.2.33 KNX Switch Actuators, 4 channel with KNX Secure > Channel A-... > A:Monitor		
General	Cyclic monitoring control value --in minutes (0...240 minutes)	60
Channel A-...	--in seconds (0...59 seconds)	0
A:Function	Valve position during fault	10%(26)
A:Monitor	Report fault status	<input checked="" type="checkbox"/>

Fig. 4.5.1 Parameter window “X: Monitoring”

Parameter “Cyclic monitoring control value --in minutes (0...240 minutes) / --in seconds (0...59 seconds)”

These two parameters define the time that the relay monitors the telegram.

Generally speaking, the room thermostat will send the control telegram to the switch actuator at specific intervals. If one or more of the consecutive telegram is omitted, this may indicate a communications fault or a room thermostat malfunction.

During the set monitoring time, the switch actuator cannot receive the control telegram for the thermostat; the output will switch to the fault mode and trigger a position during fault.

The fault mode ends as soon as a telegram is received as a control value. And the monitor time will also be recounted when receiving the new control telegram. Options:

0...240 minutes

0...59 seconds

Note: if this function is activated, the room thermostat must periodically send out control telegram. The monitoring time shall be greater than the interval time of control telegram sent by the controller.

Parameter “Valve position during fault”

This parameter defines the valve position that the switch actuator controls in fault mode. Options:

0 % (OFF)

10 % (26)

...

90 % (230)

100 % (ON)

Unchange

Unchange: the valve position is unchanged.

Parameter “Report fault status”

This parameter sets whether to send telegram to report fault mode under fault mode.

If enabled, when the device does not receive the control value within the monitoring time, it will send an error report, and this output will perform the dynamic action under the fault mode until it is interrupted by other operations. When the device receives the control value again, the monitoring time timing of this output starts again.

The object “Report fault” will be activated when enabled. When the value of the communication object “Report fault” is “1”, means that this output enters into the fault mode. When the value is “0”, the output is not in the fault mode.

4.5.2. Parameter window “X: Forced”

The function “X: Forced” in Fig. 4.5.2 will be visible if it is enabled in the function “Function of forced operation” in Fig. 4.5(2).

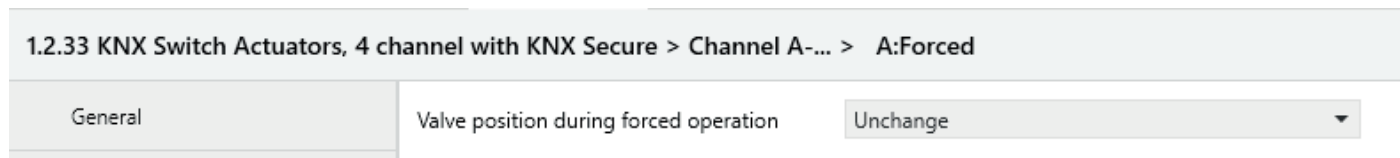

Fig. 4.5.2 Parameter window “X: Forced”

In the forced operation mode, the channel is forced to switch to the set position.

The forced operation mode has the highest priority, all operations except forced operation will be ignored.

This mode can be activated through the communication object “Forced operation,” = “1” and ends when “Forced operation,” = “0”.

Parameter “Valve position during forced operation”

This parameter defines the valve position that is triggered by the actuator during the forced operation. Options:

0 % (OFF)

10 % (26)

...

90 % (230)

100 % (ON)

Unchange

Unchange: the valve position is unchanged.

When the forced operation is exited, the valve output is going back to the previous operation. For example, the valve position under the forced operation is 40%, and the previous operation is 60%. After exiting the forced operation, the valve output will return to the 60% valve position.

During forced operation, monitoring time of the monitor is still continuous, and when the monitoring time is up, an error report will be sent, but the action under the fault cannot be executed, and it can only be executed after the forced operation is exited. During the forced operation, the received control telegram of common operation will be recorded.

4.5.3. Parameter window “X: Regular”

The window of “X: Regular” in Fig. 4.5.3 will pop out when it is enabled in the parameter “Function of regularswitch” in Fig.4.5(2).

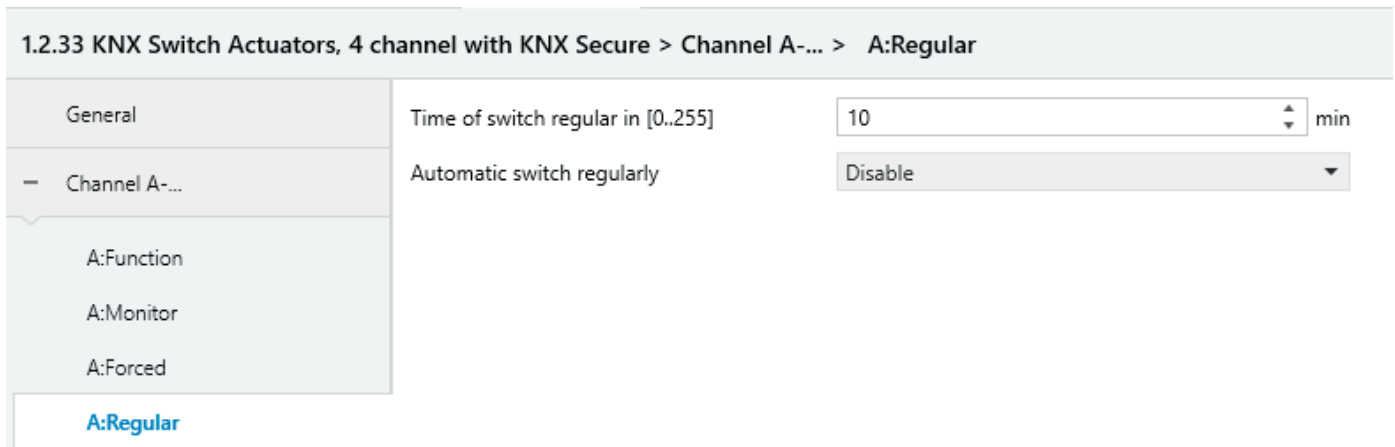

Fig. 4.5.3 Parameter window “X: Regular”

This function can be used to avoid the device’s malfunction because of the dust deposits in the valve area, which plays a very important role when in the long unchange switch status.

This function can be started by the object “Trigger switch regularly” or internally.

Parameter “Time of switch regularin [0...255]”

This parameter defines the time span when the regularswitch carry out one action, and whose unit is minute. Options: **0...255 min**

Parameter “Automatic switch regularly”

This parameter defines the time interval of starting the automatic regularswitching. Options:

- Disable**
- One times per day**
- One times per week**
- One times per month**

It will start the time counting of the automatic regular switch function if there is no operation on the relays, and recount as long as the relays have operation.

4.5.4. Parameter window “X: Safety”

The parameter window “X: Safety” in Fig. 4.5.4 will pop out when it is enabled in the parameter “Function of safety operation is” in Fig. 4.5(2) .

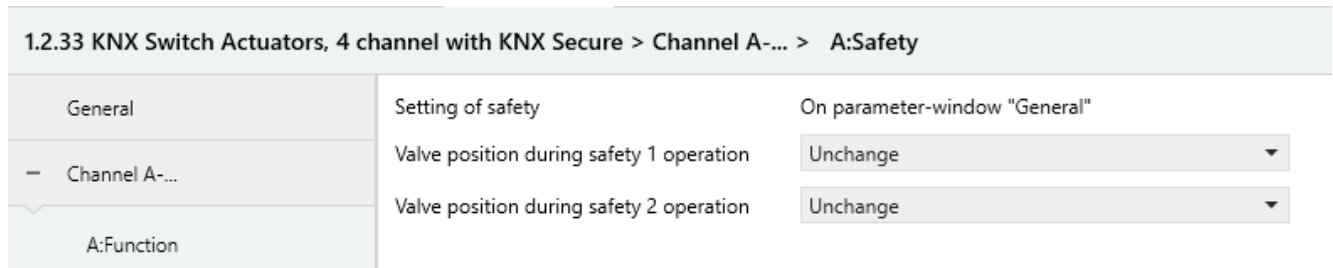

Fig. 4.5.4 Parameter window “X: Safety”

There are 2 “Safety Priority x” (x=1,2) in the parameter window “General”.

The parameter defines the valve position triggered by the actuator during safety operation.

There are 2 individual “Safety Priority x” (x=1,2) for every output, and “Safety Priority 2” is prior to “Safety Priority 1”. That is even if “Safety Priority 1” is triggered at the same time with “Safety Priority 2”, the contact position will follow the instruction of “Safety Priority 2”.

The priority of the safe operation function is only lower to the forced operation function in the system.

Parameter “Valve position during safety X operation” (x=1,2)

This parameter defines the valve position that is triggered by the actuator during the safety operation. Options:

0 % (OFF)

10 % (26)

...

100 % (ON)

Unchange

Unchange: the valve position is unchanged.

At the end of safety operation mode, the valve output status will return to the previous operation. For example, if the valve position is 40% under safe operation and 60% before operation, the valve output status will return to 60% after exiting safety operation.

Chapter 5. Description of communication object

The communication object is a media that the bus talks to the other devices, that means only communication object can have the right to communicate to the bus. More details will be described below.

NOTE: “C” in “Flag” column in the below table means that the object has a normal link to the bus; “W” means the object value can be modified via the bus; “R” means the value of the object can be read via the bus; “T” means that a telegram is transmitted when the object value has been modified; “U” means that value response telegrams are interpreted as a write command, the value of the object is updated.

5.1. Communication object “General”

There are 3 objects in “General”, which plays important role in the regular Switch actuator and Heating actuator. See in Fig. 5.1 and functions are shown in Table 5.1.

Number	Name	Object Function	Description	Group Address	Length	C	R	W	T	U	Data Type	Priority
1	General	In operation			1 bit	C	R	-	T	-	switch	Low
2	General	Safety priority 1			1 bit	C	-	W	-	U	enable	Low
3	General	Safety priority 2			1 bit	C	-	W	-	U	enable	Low

Fig. 5.1 Communication object “General”

No.	Function	Object name	Data type	Flags	DPT
1	In operation	General	1bit	C,R,T	1.001 switch
<p>This object is always enabled, used to send telegram “1” to the bus periodically to proof the device is under normal working condition.</p>					
2	Safety Priority 1	General	1bit	C,W,U	1.003 enable
<p>It is able to receive the 1bit telegram from the other devices (such as sensors and controllers and so on) and modify the running condition of the other devices by this object. The other devices will be judged as malfunction if this object doesn’t receive the relevant telegram for a certain time (which will be defined in the window “All General”), and then it will trigger the set action of “Safety Priority 1” in “X: Safety”. The priority of “Safety Priority 1” is lower only to “Forced operation” and “Safety Priority 2”.</p>					
3	Safety Priority 2	General	1bit	C,W,U	1.003 enable
<p>This object has the same function as “Safety Priority 1”, but its priority level is secondary only to “Force”.</p>					

Table 5.1 Communication object table “All General”

5.2. Communication object “Switch actuator”

5.2.1. General communication object “Switch actuator”

Number	Name	Object Function	Description	Group Address	Length	C	R	W	T	U	Data Type	Priority
4	Output A-...	Switch status			1 bit	C	R	-	T	-	switch	Low
5	Output A-...	Switch			1 bit	C	-	W	-	-	switch	Low

Fig. 5.2.1 General communication object per output

No.	Function	Object name	Data byte	Flags	DPT
4	Switch status	Output A-{{...}}	1bit	C,R,T	1.001 switch
<p>This object will be enabled when selecting “Transmit after change/Respond after read only” in the parameter “Set the reply mode of switch status”, which will indicate the contact status (details will be defined by parameter “Object value of switch status” in “Channel X”).</p> <p>The name in parentheses changes with the parameter “Description (max.30 char.)”. If description is empty, display “Output A-...” by default. The same below.</p>					
5	Switch	Output A-{{...}}	1bit	C,W	1.001 switch
<p>This object is used to trigger the switch operation. It will start the switch operation with “1”, and end with “0”.</p> <p>When enabling “input 0” in the logic function, the object “Switch, X” is used to modify the logic value of “input 0”, rather than trigger the switch operation.</p>					

Table 5.2.1 General communication table per output

5.2.2. Time function object of “Switch actuator”

6	Output A-...	Switch out with delay	1 bit	C - W - -	switch	Low
6	Output A-...	Switch out with flashing	1 bit	C - W - -	switch	Low
6	Output A-...	Output of staircase lighting	1 bit	C - W - -	switch	Low
7	Output A-...	Switch time function	1 bit	C - W - -	enable	Low
8	Output A-...	Warning of staircase	1 bit	C - - T -	alarm	Low
9	Output A-...	Duration of staircase	2 bytes	C R W - -	time (s)	Low

Fig. 5.2.2 “Switch Actuator” timing communication object for every output

No.	Function	Object name	Data type	Flags	DPT
6	Output of staircase lighting	Output A-{{...}}	1bit	C,W	1.001 switch
<p>It is used to switch on the staircase lighting by this object, which will be enabled when selecting “Staircase lighting” in the parameter “The mode of time function”.</p>					
6	Switch out with delay	Output A-{{...}}	1bit	C,W	1.001 switch
<p>It is used to switch on the time delay by this object, which will be enabled when selecting “Delay switch” in the parameter “The mode of time function”.</p>					
6	Switch out with flashing	Output A-{{...}}	1bit	C,W	1.001 switch
<p>It is used to switch on the flash output by this object, which will be enabled when selecting “Flashing switch” in the parameter “The mode of time function”.</p>					
7	Switch time function	Output A-{{...}}	1bit	C,W	1.003 enable
<p>This object will be started when enabling the time function which can be enabled by this object. It will enable the timing function when receiving the value “1”; time function will disable it when receiving “0”. After the time function is disabled, the current delay time counter will be cleared, and the delaying operation will be ignored, apply to delay switch/flash switch/staircase lighting.</p> <p>Enable is a default setting for the time function after bus voltage recovery.</p>					
8	Warning of staircase	Output A-{{...}}	1bit	C,T	1.005 alarm
<p>It will be enable while selecting warning by this object in the parameter “Warning mode for ending of staircase”. It will send “1” to the bus when the alarm is starting.</p>					
9	Duration of staircase	Output A-{{...}}	2byte	C,W,R	7.005 time (s)
<p>This object will be enabled when selecting “enable” in the parameter “Modify the duration via object (0...60059 seconds)” to modify the duration of the staircase lighting.</p>					

Table 5.2.2 Timing function communication table

5.2.3. Preset function object of “Switch actuator”

10	Output A-...	Recall preset	1 bit	C - W - -	scene	Low
11	Output A-...	Store preset	1 bit	C - W - -	scene	Low

Fig. 5.2.3 Preset function communication object for every output of “Switch Actuator”

No.	Function	Object name	Data type	Flags	DPT
10	Recall preset	Output A-{{...}}	1bit	C,W	1.022 scene
This object is used to call the preset value;telegram “0” with “0” and telegram “1” with “1”					
11	Store preset	Output A-{{...}}	1bit	C,W	1.022 scene
It can be used to save the current switch status as the new preset value; save the new telegram “0” with “0” and telegram “1” with “1”.					

Table 5.2.3 Preset communication objects

5.2.4. Logic function object of “Switch actuator”

12	Output A-...	Input 1 of logic	1 bit	C - W - -	boolean	Low
13	Output A-...	Input 2 of logic	1 bit	C - W - -	boolean	Low

Fig. 5.2.4 Logic function communication object for every output of “Switch Actuator”

No.	Function	Object name	Data type	Flags	DPT
12	Input 1 of logic	Output A-{{...}}	1bit	C,W	1.002 boolean
This object will be enabled when selecting “Enable” in the parameter “The input 1 of logic is”.					
13	Input 2 of logic	Output A-{{...}}	1bit	C,W	1.002 boolean
This object will be enabled when selecting “Enable” in the parameter “The input 2 of logic is”.					

Table 5.2.4 Logic function communication objects

5.2.5. Scene function object of “Switch actuator”

14	Output A-...	Scene	1 byte	C - W - -	scene control	Low
----	--------------	-------	--------	-----------	---------------	-----

Fig. 5.2.5 Scene function communication object of “Switch Actuator”

No.	Function	Object name	Data type	Flags	DPT
14	Scene	Output A-{{...}}	1Byte	C,W	18.001 scene control
<p>It is able to recall or save the scene when sending an 8-bit command by this object, which will be enabled when enabling the scene function. The definition of the 8-bit command will be described below:</p> <p>Assuming an 8-bit command (binary coding) as: FXNNNNNN</p> <p style="padding-left: 40px;">F: recall the scene with “0”; save the scene with “1”;</p> <p style="padding-left: 40px;">X: 0</p> <p style="padding-left: 40px;">NNNNNN: scene number (1-64).</p> <p>1-64 in the parameter setup corresponds to the scene number 0-63 received by the communication object “Scene handle”. For example, scene 1 in the parameter setup has the same output result as scene 0 in the communication object “Scene handle”.</p>					

Table 5.2.5 Scene function communication object “Switch Actuator”

5.2.6. Threshold function object of “Switch actuator”

15	Output A-...	Change threshold 1	1 byte	C - W - -	counter pulses (0..255)	Low
16	Output A-...	Threshold input	1 byte	C - W - -	counter pulses (0..255)	Low

Fig. 5.2.6 Threshold function communication object “Switch Actuator”

No.	Function	Object name	Data type	Flags	DPT
15	Change threshold 1	Output A-{{...}}	1Byte	C,W	5.010 counter pulses
<p>This object is used to change the value of the threshold 1.</p>					
16	Threshold input	Output A-{{...}}	1Byte	C,W	5.010 counter pulses
<p>This object is used to receive the threshold sent by other devices.</p>					

Table 5.2.6 Threshold function communication object

5.2.7. Forced function object “Switch actuator”

17	Output A-...	Forced operation	1 bit	C - W - -	switch	Low
17	Output A-...	Forced operation	2 bit	C - W - -	switch control	Low

Fig. 5.2.7 Forced function communication object “Switch Actuator”

No.	Function	Object name	Data type	Flags	DPT
17	Forced operation	Output A-{{...}}	1bit	C,W	1.003 enable
<p>This object will be started after enabling the 1bit forced function. Enable the forced function with “1”, and the other behaviors will be ignored except the forced function; enable the forced function with “0”.</p>					
17	Forced operation	Output A-{{...}}	2bit	C,W	2.001 switch control
<p>This object will be started after enabling the 2bit forced function. The contact is forcibly closed when the message value “3” is received; The contact is forcibly disconnected when the message value “2” is received; the enforcement mode is canceled when the message value “1” or “0” is received.</p>					

Table 5.2.7 Forced function communication objects

5.3. Communication object “Heating actuator”

5.3.1. General communication object “Heating actuator”

Number	Name	Object Function	Description	Group Address	Length	C	R	W	T	U	Data Type	Priority
4	Output A-...	Switch status			1 bit	C	R	-	T	-	switch	Low
5	Output A-...	On-Off			1 bit	C	-	W	-	-	switch	Low
6	Output A-...	Status (continuous),1 bit			1 bit	C	R	-	T	-	switch	Low
14	Output A-...	Status (continuous),1 byte			1 byte	C	R	-	T	-	percentage (0..100%)	Low
15	Output A-...	Continuous control			1 byte	C	-	W	-	-	percentage (0..100%)	Low

Fig. 5.3.1 General communication object “Heating actuator”

No.	Function	Object name	Data type	Flags	DPT
15	Continuous control	Output A-{{...}}	1Byte	C,W	5.001 percentage
<p>This object will be enabled when selecting “1byte (continues)” in the parameter “Control telegram is received as”, is used to receive the control command of 1Byte, with range from 0% to 100%: the valve will be off with “0%”, on with “100%”.</p>					
5	On-Off	Output A-{{...}}	1bit	C,W	1.001 switch
<p>This object will be enabled when selecting “1bit on-off control” in the parameter “Control telegram is received as”, to receive the command of 1bit: off with “0”; on with “1”.</p>					
14	Status (continuous),1 byte	Output A-{{...}}	1Byte	C,R,T	5.001 percentage
<p>This object will be enabled when selecting “yes, continues control value (1byte)” in the parameter “Reply the status of channel for continuous control”, indicating the running status of the current valve and the duty cycle of PWM.</p>					
6	Status (continuous),1 bit	Output A-{{...}}	1bit	C,R,T	1.001 switch
<p>This object will be enabled when selecting “yes, 0% =‘0’, otherwise ‘1’ (1 bit)” or “yes, 0% =‘1’, otherwise ‘0’ (1 bit)” in the parameter “Reply the status of channel for continuous control”, indicating the running status of the current valve.</p> <p>When selecting “yes, 0% =‘0’, otherwise ‘1’ (1 bit)”, the valve will be off with “0”, others with “1”; selecting “yes, 0% =‘1’, otherwise ‘0’ (1 bit)”, the valve will be off with “1”, others with “0”</p>					
4	Switch status	Output A-{{...}}	1bit	C,R,T	1.001 switch
<p>This object will be enabled when selecting “‘1’= contact close; ‘0’=contact open” or “yes, ‘0’= contact close; ‘1’=contact open” in the parameter “Reply the status of contact state”; indicating the contact position of the current relay.</p>					

Table 5.9 General communication objects “Heating actuator”

5.3.2. Monitoring function object of “Heating actuator”



Fig. 5.3.2 Monitoring function communication object “Heating actuator”

No.	Function	Object name	Data type	Flags	DPT
8	Report fault	Output A-{{...}}	1bit	C,R,T	1.005 alarm
<p>This object is enabled when selecting “enable” in the parameter “Extension function”, used to check whether the room thermostat is under malfunction or not. It will go into the fault mode with “1”.</p>					

Table 5.3.2 Monitoring communication objects “Heating actuator”

5.3.3. Forced function object “Heating actuator”



Fig. 5.3.3 Forced function communication object “Heating actuator”

No.	Function	Object name	Data byte	Flags	DPT
17	Forced operation	Output A-{{...}}	1bit	C,W	1.003 enable
<p>This object will be started when enabling the forced function. Start the forced mode with “1” and the other behaviors will be ignored; end the mode with “0”.</p>					

Table 5.3.3 Forced function communication object “Heating actuator”

5.3.4. Regular switch function object “Heating actuator”



Fig. 5.3.4 Regularswitch function communication object “Heating actuator”

No.	Function	Object name	Data type	Flags	DPT
11	Trigger switch regularly	Output A-{{...}}	1bit	C,W	1.001 switch

This object will be visible when enabling the regular switch function, to trigger the regular switch. Send telegram "1" to turn on the regularswitch, when the timing time is up to the end of the operation, return to the previous operation, or send telegram "0" to end the operation. The priority of the regular switch is higher than the normal operation, but lower than the safety and forced operation.

Table 5.3.4 Regularswitch function communication objects “Heating actuator”

Chapter 6. Priority level description

There are 5 priority levels for the whole system:

Switch actuator function: Forced > Safety Priority 2 > Safety Priority 1 > common switch / Time/ preset / logic / scene / threshold (from highest priority to lowest)

Heating actuator function: Forced > Safety Priority 2 > Safety Priority 1 > Regular switch -> monitoring operation / general operation

Only the higher priority behavior can interrupt the lower priority behavior.

General switch:

Forced operation

Safety priority 2

Safety priority 1

Switch

Channel special function switch: output of time/preset/logic/scene/threshold and other functions.

Dynamic adjustment:

Forced operation

Safety priority 2

Safety priority 1

Switch regularly

Monitoring/general operation: monitor/PWM, continue, on-off

NOTE:

After the higher priority is canceled, the device will check whether the lower priority is enabled, if enabled, the corresponding configuration will be performed.

The device works in the switch actuator mode. If the Flash / Staircase / Delay time function is running before entering the high priority, then their time will continue to count during the high priority operation. Then after exit at the high priority, if the timing is still not over, the time function will

continue to execute. And during high priority, the control telegrams of channel switches and special switches function from the bus are ignored.

The device works in the heating actuator mode. During the high-priority operation, the monitoring time of the monitor continues, and a fault report will be sent when the monitoring time has passed, but the operation during the fault cannot be performed, and it can only be performed after exiting the high-priority operation. And during the high-priority operation, the control telegram of the normal operation / regular switch from the bus will be recorded, and the timing time for the regular switch is accounted, if the time has not passed after the high-priority operation ends, the regular switching operation will continue to be executed, if the time has elapsed, the regular switching operation will not be performed.